

**NAD**

**T 571**

DVD / CD / MP3 Player



**GB** Owner's Manual

## Safety Precautions

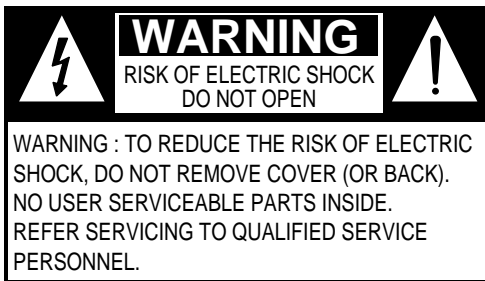

The lightning flash with arrowhead symbol, within an equilateral triangle, is intended to alert the user to the presence of uninsulated 'dangerous voltage' within the product's enclosure that may be of sufficient magnitude to constitute a risk of electric shock to persons.



The exclamation point within an equilateral triangle is intended to alert the user to the presence of important operating and maintenance (servicing) instructions in the literature accompanying the appliance.

**WARNING:** TO REDUCE THE RISK OF FIRE OR ELECTRIC SHOCK, DO NOT EXPOSE THIS PRODUCT TO RAIN OR MOISTURE.

**CAUTION:** TO PREVENT ELECTRIC SHOCK, MATCH WIDE BLADE OF PLUG TO WIDE SLOT, FULLY INSERT.

**ATTENTION:** POUR EVITER LES CHOCS ELECTRIQUE, INTRODUIRE LA LAME LA PLUS LARGE DE LA FICHE DANS LA BORNE CORRESPONDANTE DE LA PRISE ET POUSSER JUSQU'AU FOUD.

**CAUTION:** This Digital Video Disc Player employs a Laser System. To ensure proper use of this product, please read this owner's manual carefully and retain for future reference, should the unit require maintenance, contact an authorized service location-see service procedure.

Use of controls, adjustments or the performance of procedures other than those specified herein may result hazardous radiation exposure.

To prevent direct exposure to laser beam, do not try to open the enclosure. Visible laser radiation when open. DO NOT STARE INTO BEAM.

**FCC NOTICE:** This equipment has been tested and found to comply with the limits for a Class B digital device, pursuant to part 15 of the FCC Rules. These limits are designed to provide reasonable protection against harmful interference in a residential installation. This equipment generates, uses, and can radiate radio frequency energy and, if not installed and used in accordance with the instructions, may cause harmful interference to radio communications. However, there is no guarantee that interference will not occur in a particular installation. If this equipment does cause harmful interference to radio or television reception, which can be determined by turning the equipment off and on, the user is encouraged to try to correct the interference by one or more of the following measures:

- Reorient or relocate the receiving antenna.
- Increase the separation between the equipment and receiver.
- Connect the equipment into an outlet on a circuit different from that to which the receiver is connected.
- Consult the dealer or an experienced radio/TV technician for help.

**FCC WARNING:** Changes or modifications not expressly approved by NAD Electronics Corporation could void the user's authority to operate the equipment.

### INDUSTRY CANADA REQUIREMENT:

This Class B digital apparatus meets all requirements of the Canadian Interference-Causing Equipment Regulations.

Cet appareil numéruque de la classe B respecte toutes les exigences du Règlement sur le matériel brouilleur du Canada.

RECORD YOUR MODEL NUMBER (Now, while you can see it)

The model and serial number of your new DVD player are located on the back of the DVD player cabinet. For your future convenience, we suggest that you record these numbers here:

MODEL NO. \_\_\_\_\_

SERIAL NO. \_\_\_\_\_

## Table of Contents

### Introduction

- ❑ Safety Precautions . . . . . 2
- ❑ Table of Contents . . . . . 3
- ❑ IMPORTANT SAFETY INSTRUCTIONS . . . . . 4-5
- ❑ Precautions . . . . . 6
- ❑ Notes on Discs . . . . . 7
- ❑ Identification of Controls . . . . . 8-11
  - Front Panel/Display Window . . . . . 8
  - Rear Panel . . . . . 9
  - Remote Control . . . . . 10
  - Preparing the Remote Control . . . . . 11
  - Operating with the Remote Control . . . . . 11

### Connections

- ❑ Connecting to Surround Sound System . . . . . 12-14
  - Enjoying Dolby Digital Sound . . . . . 12
  - Enjoying Dolby Pro Logic Surround Sound . . . . . 13
  - Enjoying 2 Channel Digital Stereo Sound . . . . . 14
  - Enjoying DTS Sound . . . . . 14
- ❑ Connecting to a Stereo System . . . . . 15
- ❑ Connecting to a TV equipped with component video inputs . . . . . 16
- ❑ Connecting to a TV . . . . . 17

### Initial Settings

- ❑ Selection of Initial Settings . . . . . 18
- ❑ Selecting Disc Languages . . . . . 19
- ❑ Selecting Parental Control Rating Level and Password . . . . . 20-21
- ❑ Selecting TV Aspect . . . . . 22
- ❑ Selecting Menu Language . . . . . 23
- ❑ Selecting Progressive Scan . . . . . 24
- ❑ Selecting Digital Audio Output . . . . . 25
- ❑ Others . . . . . 26
- ❑ Table of Languages and Their Abbreviations . . . 27

### Basic Operations

- ❑ Basic Playback . . . . . 28-31
  - Stopping Play . . . . . 30
  - Resume Play . . . . . 30
  - Last Scene Memory . . . . . 30
  - Screen Saver . . . . . 30
  - Skipping Discs . . . . . 31
  - Exchanging the Disc and Starting Playback . . . 31
- ❑ Special Playback . . . . . 32-33
  - Still Picture . . . . . 32
  - Frame Advance . . . . . 32
  - Skipping Chapters and Tracks Forward or Back . 32
  - HDCD Playback . . . . . 32
  - To Scan at Fast Forward or Fast Reverse Playback . 33
  - Playing in Slow-Motion . . . . . 33

### Operation Using GUI (Graphical User Interface) Menu Icons

- ❑ General Information about GUI Menu Icons . . . . 34
- ❑ Detailed Description of each GUI Menu Icon . . . 35

### Advanced Operation

- ❑ Using a Title Menu . . . . . 36
- ❑ Using a DVD Menu . . . . . 36
- ❑ Changing Subtitle Language . . . . . 37
- ❑ Changing Audio Soundtrack Language . . . . . 37
- ❑ Viewing from another Angle . . . . . 38
- ❑ Producing a 3D Surround Effect . . . . . 38
- ❑ Repeat Play . . . . . 39
- ❑ Storing Markers in Memory to be Viewed (Listened to) again . . . . . 40
- ❑ Zoom Feature . . . . . 41
- ❑ Random Play . . . . . 41
- ❑ Program Play . . . . . 42
- ❑ Playback with MP3 . . . . . 43-44

### Reference

- ❑ Disc Requirements/Copyright Information . . . . . 45
- ❑ Before Calling Service Personnel . . . . . 46
- ❑ Specifications . . . . . 47



# IMPORTANT SAFETY INSTRUCTIONS

**CAUTION: PLEASE READ AND OBSERVE ALL WARNINGS AND INSTRUCTIONS IN THIS OWNER'S MANUAL AND THOSE MARKED ON THE UNIT. RETAIN THIS BOOKLET FOR FUTURE REFERENCE.**

This set has been designed and manufactured to assure personal safety. Improper use can result in electric shock or fire hazard. The safeguards incorporated in this unit will protect you if you observe the following procedures for installation, use and servicing.

This unit is fully transistorized and does not contain any parts that can be repaired by the user.

**DO NOT REMOVE THE CABINET COVER, OR YOU MAY BE EXPOSED TO DANGEROUS VOLTAGE. REFER SERVICING TO QUALIFIED SERVICE PERSONNEL ONLY.**

**1. Read owner's manual**

After unpacking this product, read the owner's manual carefully, and follow all the operating and other instructions.

**2. Power Sources**

This product should be operated only from the type of power source indicated on the marking label. If you are not sure of the type of power supply in your home, consult your product dealer or local power company. For products intended to operate from battery power, or other sources, refer to the operating instructions.

**3. Grounding or Polarization**

This product is equipped with a polarized alternating current line plug (a plug having one blade wider than the other). This plug will fit into the power outlet only one way. This is a safety feature. If you are unable to insert the plug fully into the outlet, try reversing the plug. If the plug should still fail to fit, contact your electrician to replace your obsolete outlet. Do not defeat the safety purpose of the polarized plug.

**4. Ventilation**

Slots and openings in the cabinet are provided for ventilation and to ensure reliable operation of the product and to protect it from overheating. These openings must not be blocked or covered. The openings should never be blocked by placing the product on a bed, sofa, rug or other similar surface. This product should not be placed in a built-in installation such as a bookcase or rack unless proper ventilation is provided or the manufacturer's instructions have been adhered to.

**5. Heat**

The product should be situated away from heat sources such as radiators, heat registers, stoves, or other products (including amplifiers) that produce heat.

**6. Water and Moisture**

Do not use this product near water—for example, near a bath tub, wash bowl, kitchen sink, or laundry tub; in a wet basement; or near a swimming pool and the like.

**7. Cleaning**

Unplug this product from the wall outlet before cleaning. Do not use liquid cleaners or aerosol cleaners. Use a damp cloth for cleaning.

**8. Power-Cord Protection**

Power-supply cords should be routed so that they are not likely to be walked on or pinched by items placed upon or against them, paying particular attention to cords at plugs, convenience receptacles, and the point where they exit from the product.

**9. Overloading**

Do not overload wall outlets, extension cords, or integral convenience receptacles as this can result in a risk of fire or electric shock.

**10. Lightning**

For added protection of this product during storms, or when it is left unattended and unused for long periods of time, unplug it from the wall outlet. This will prevent damage to the product due to lightning and power-line surges.

**11. Object and Liquid Entry**

Never push objects of any kind into this product through openings as they may touch dangerous voltage points or short-out parts that could result in a fire or electric shock. Never spill liquid of any kind on the product.

**12. Attachments**

Do not use attachments not recommended by the product manufacturer as they may cause hazards.

# IMPORTANT SAFETY INSTRUCTIONS (Cont'd)

## 13. Accessories, Carts, and Stands

Do not place this product on an unstable cart, stand, tripod, bracket, or table. The product may fall, causing serious injury to a child or adult, and serious damage to the product. Use only with a cart, stand, tripod, bracket, or table recommended by the manufacturer, or sold with the product. Any mounting of the product should follow the manufacturer's instructions, and should use a mounting accessory recommended by the manufacturer. A product and cart combination should be moved with care. Quick stops, excessive force, and uneven surfaces may cause the product and cart combination to overturn.



## 14. Disc Tray

Keep your fingers well clear of the disc tray as it is closing. It may cause serious personal injury.

## 15. Burden

Do not place a heavy object on or step on the product. The object may fall, causing serious personal injury and serious damage to the product.

## 16. Connecting

When you connect the product to other equipment, turn off the power and unplug all of the equipment from the wall outlet. Failure to do so may cause an electric shock and serious personal injury. Read the owner's manual of the other equipment carefully and follow the instructions when making any connections.

## 17. Sound Volume

Reduce the volume to the minimum level before you turn on the product. Otherwise, sudden high volume sound may cause hearing or speaker damage.

## 18. Sound Distortion

Do not allow the product to output distorted sound for a longtime. It may cause speaker overheating and fire.

## 19. Headphones

When you use the headphones, keep the volume at a moderate level. If you use the headphones continuously with high volume sound, it may cause hearing damage.

## 20. Laser Beam

Do not look into the opening of the disc tray or ventilation opening of the product to see the source of the laser beam. It may cause sight damage.

## 21. Disc

Do not use a cracked, deformed, or repaired disc. These discs are easily broken and may cause serious personal injury and product malfunction.

## 22. Damage Requiring Service

Unplug this product from the wall outlet and refer servicing to qualified service personnel under the following conditions:

- a) When the power-supply cord or plug is damaged.
- b) If liquid has been spilled, or objects have fallen into the product.
- c) If the product has been exposed to rain or water.
- d) If the product does not operate normally by following the operating instructions. Adjust only those controls that are covered by the operating instructions as an improper adjustment of other controls may result in damage and will often require extensive work by a qualified technician to restore the product to its normal operation.
- e) If the product has been dropped or damaged in any way.
- f) When the product exhibits a distinct change in performance-this indicates a need for service.

## 23. Servicing

Do not attempt to service this product yourself as opening or removing covers may expose you to dangerous voltage or other hazards. Refer all servicing to qualified service personnel.

## 24. Replacement parts

When replacement parts are required, be sure the service technician has used replacement parts specified by the manufacturer or have the same characteristics as the original part. Unauthorized substitutions may result in fire, electric shock, or other hazards.

## 25. Safety Check

Upon completion of any service or repairs to this product, ask the service technician to perform safety checks to determine that the product is in proper operating condition.

## Precautions

### Notes on handling

- ❑ When shipping the DVD player, always use the original shipping carton and packing materials. For maximum protection, repack the unit as it was originally packed at the factory.
- ❑ Do not use volatile liquids, such as insect spray, near the DVD player. Do not leave rubber or plastic products in contact with the DVD player for a long time. They will leave marks on the finish.
- ❑ The top and rear panels of the DVD player may become warm after a long period of use. This is normal and not a malfunction.
- ❑ When the DVD player is not in use, be sure to remove the disc and turn off the power.
- ❑ If you do not use the DVD player for a long period, the unit may not function properly in the future. Turn on and use the DVD player occasionally.

### Notes on Locating

- ❑ When you place this DVD player near a TV, radio, or VCR, the playback picture may become poor and the sound may be distorted. In this case, move the DVD player away from the TV, radio, or VCR.

### Notes on Cleaning

Use a soft, dry cloth for cleaning.

- ❑ For stubborn dirt, soak the cloth in a weak detergent solution, wring well and wipe. Use a dry cloth to wipe it dry. Do not use any type of solvent, such as thinner and benzine, as they may damage the surface of the DVD player.
- ❑ If you use a chemical saturated cloth to clean the unit, follow that product's instructions.

**Warning:** Cleaning and adjustment of lenses and/or other components of playback mechanism should be performed by a qualified service technician.

### Notes on Moisture Condensation

Moisture condensation damages the DVD player. Please read the following carefully.

Moisture condensation occurs, for example, when you pour a cold drink into a glass on a warm day. Drops of water form on the outside of the glass. In the same way, moisture may condense on the optical pick-up lens inside this unit, one of the most crucial internal parts of the DVD player.

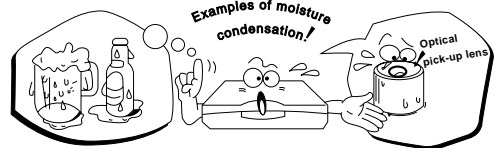

Moisture condensation occurs during the following cases.

- ❑ When you bring the DVD player directly from a cold place to a warm place.
- ❑ When you use the DVD player in a room where you just turned on the heater, or a place where the cold wind from the air conditioner directly hits the unit.
- ❑ In summer, when you use the DVD player in a hot and humid place just after you move the unit from an air conditioned room.
- ❑ When you use the DVD player in a humid place.

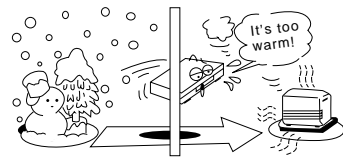

- ❑ **Do not use the DVD player when moisture condensation may occur.**

If you use the DVD player in such a situation, it may damage discs and internal parts. Remove the disc, connect the power cord of the DVD player to the wall outlet, turn on the DVD player and leave it "ON" for two or three hours. After two or three hours, the DVD player will have warmed up and evaporated any moisture. Keep the DVD player connected to the wall outlet and moisture condensation will seldom occur.

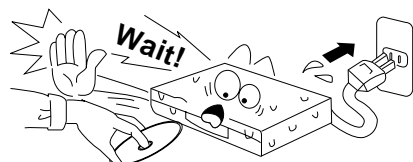

## Notes on Discs

This section shows you how to handle, clean, and store discs.

### On Handling Discs

- Do not touch the playback side of the disc.

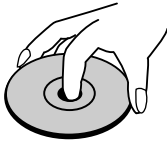

- Do not attach paper or tape to discs.



### On Storing Discs

- Do not store discs in a place subject to direct sunlight or near heat sources.
- Do not store discs in places subject to moisture and dust such as a bathroom or near a humidifier.
- Store discs vertically in a case. Stacking or placing objects on discs outside of their case may cause warping.

### On Cleaning Discs

- Fingerprints and dust on the disc cause picture and sound deterioration. Wipe the disc from the center outward with a soft cloth. Always keep the disc clean.
- If you cannot wipe off the dust with a soft cloth, wipe the disc lightly with a slightly moistened soft cloth and finish with a dry cloth.
- Do not use any type of solvents such as thinner, benzine, commercially available cleaners or anti-static spray for vinyl LPs. They may damage the disc.

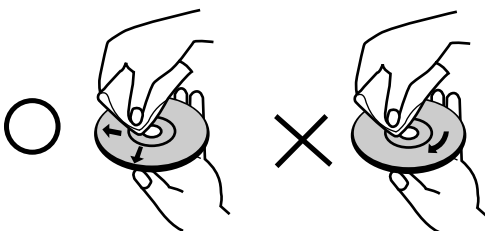

### About This Owner's Manual

- This owner's manual explains the basic instructions of this DVD player.
- Some DVD video discs have functions that may not be explained in this owner's manual. Therefore, some instructions may differ from this owner's manual, and there may be extra instructions. In this case, follow the instructions displayed on the TV screen or package.
- "⊘" may appear on the TV screen during operation. This icon means the function explained in this owner's manual is not available on that specific DVD video disc.

Identification of Controls

Front Panel

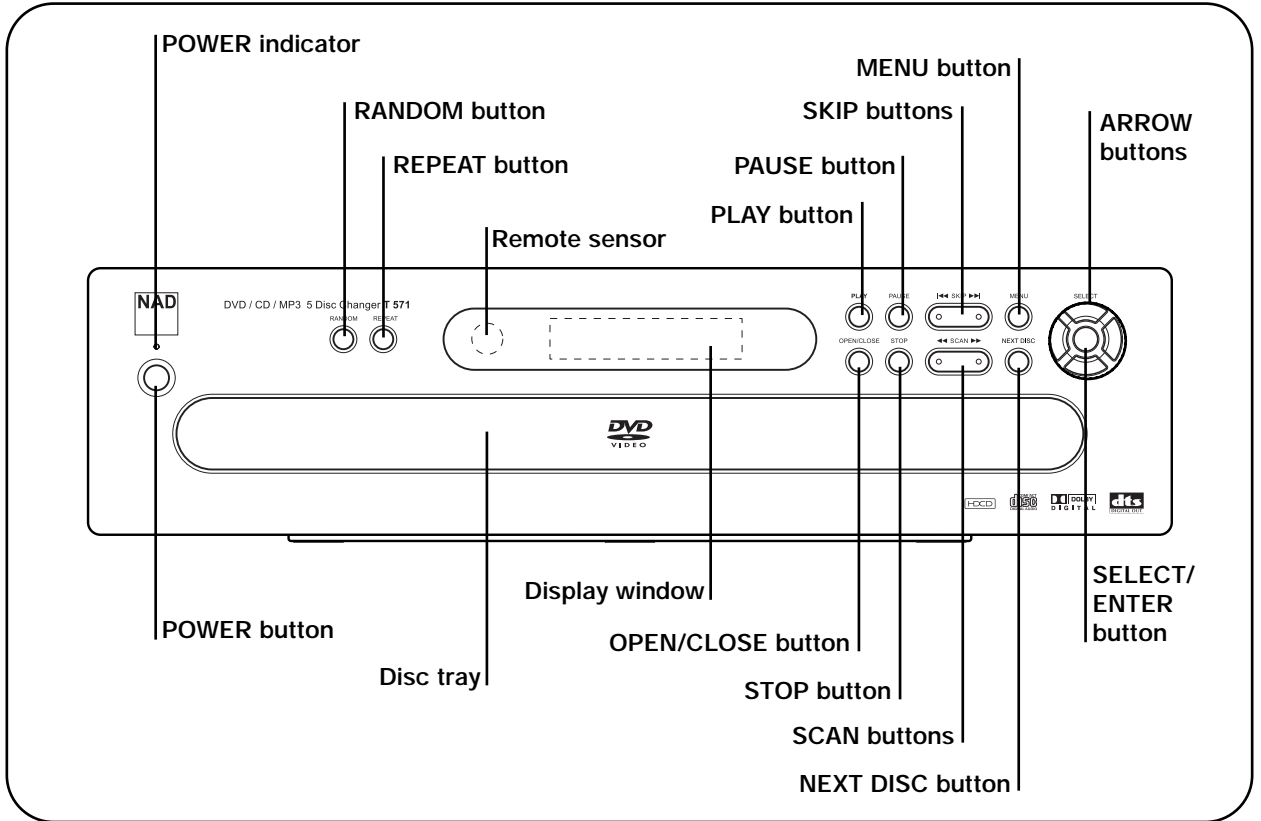

Display Window

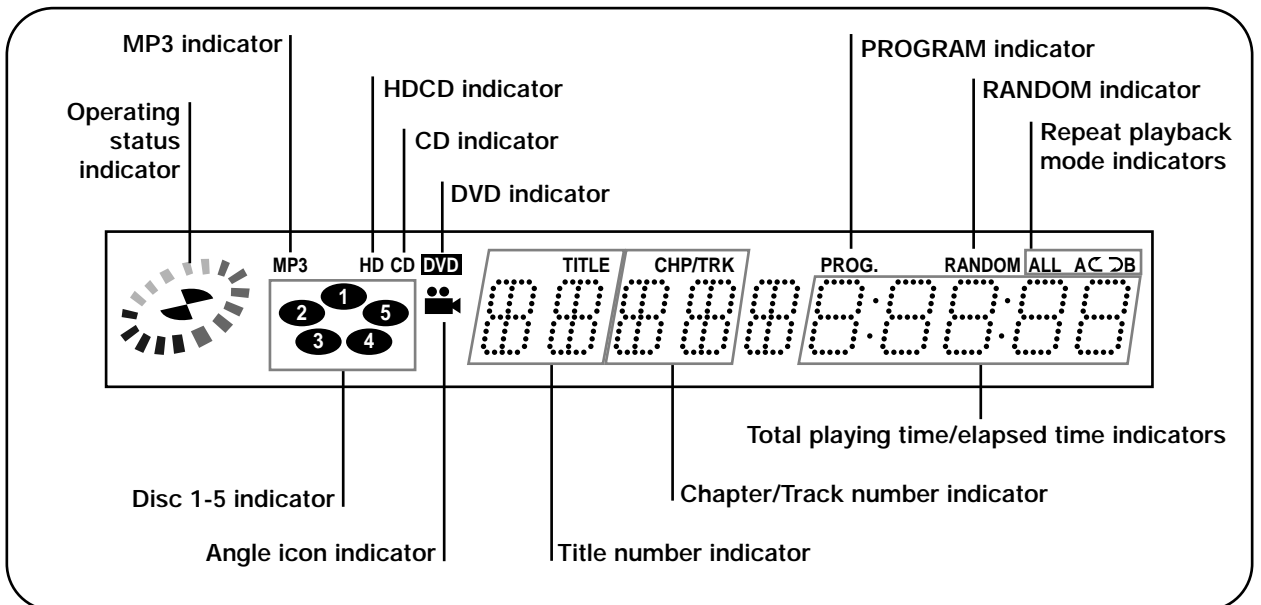



Identification of Controls (Cont'd)

Rear Panel

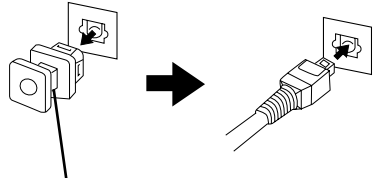
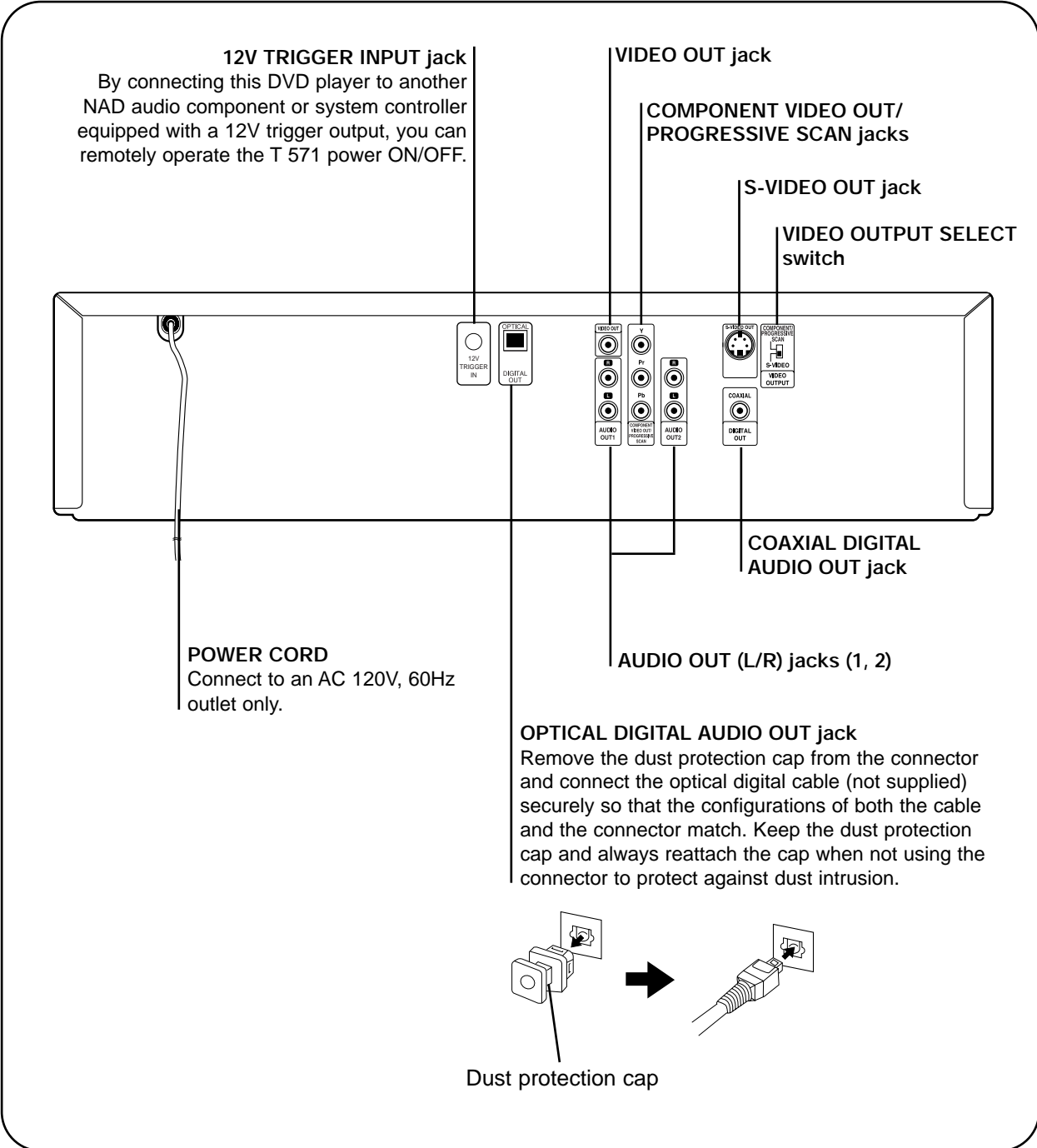

Dust protection cap

Identification of Controls (Cont'd)

Remote Control

You will find instructions for each of the remote control functions in the appropriate sections of this instruction manual.

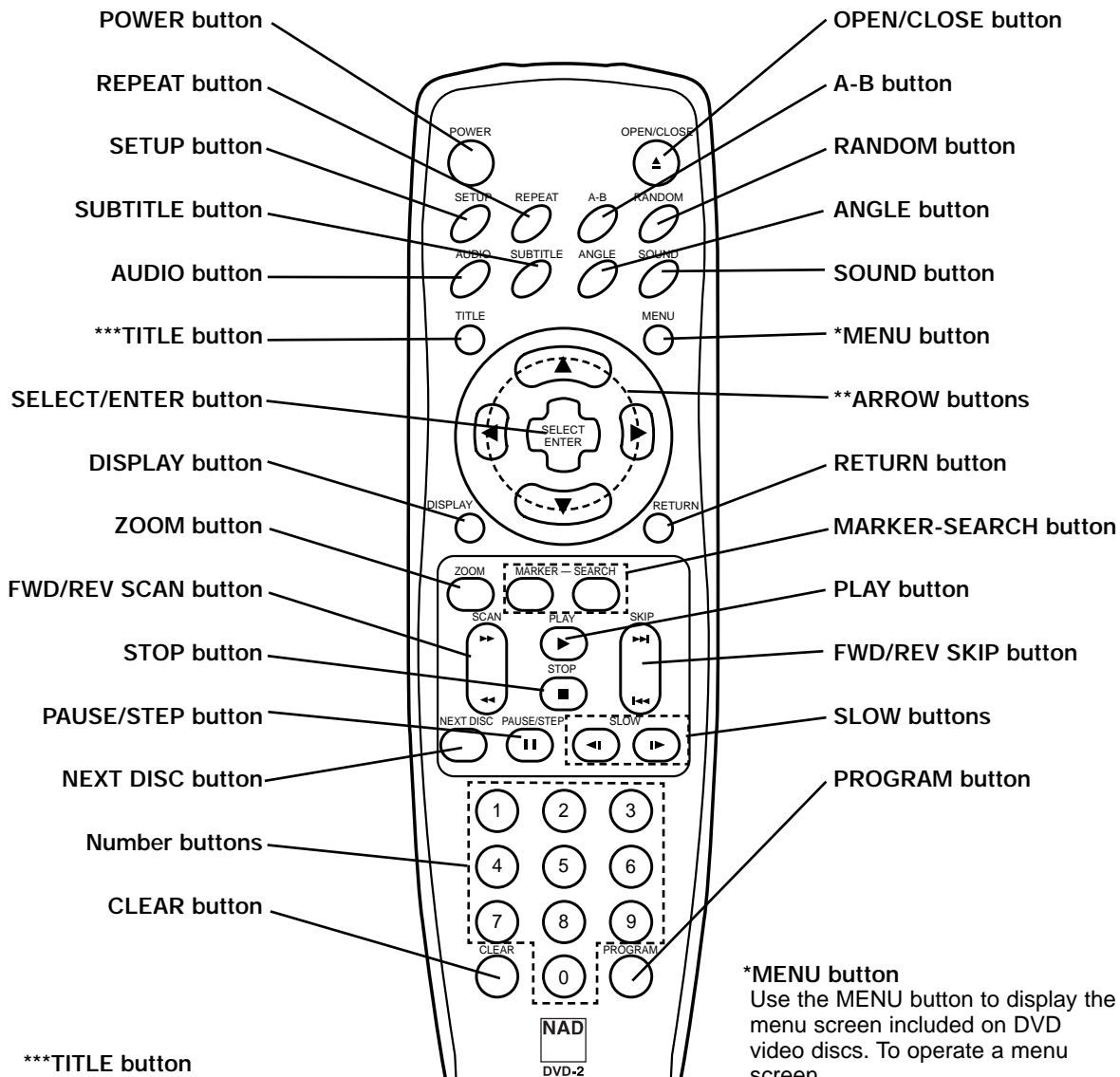

**\*\*\*TITLE button**  
Use the TITLE button to display the title screen included on DVD video discs. To operate a menu screen, follow the instructions in "Using a Title Menu" (page 36).

**\*MENU button**  
Use the MENU button to display the menu screen included on DVD video discs. To operate a menu screen, follow the instructions in "Using a DVD Menu" (page 36).

**\*\* Directional arrow buttons**  
(up, down, left, right) for use in highlighting a selection on a GUI menu screen, TITLE and MENU screen.

## Identification of Controls (Cont'd)

### Preparing the Remote Control

Insert the batteries into the remote control so you can use it to operate the DVD player.

**1** Open the battery cover.

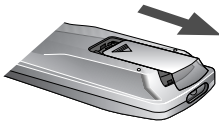

**2** Insert batteries (AAA size).



- Make sure to match the + and - on the batteries to the marks inside the battery compartment.

**3** Close the cover.

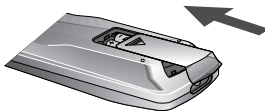

#### Notes on batteries

- Improper use of batteries may cause battery leakage and corrosion.
- To operate the remote control correctly, follow the instructions.
- Do not insert the batteries into the remote control in the wrong direction.
- Do not charge, heat, open, or short-circuit the batteries. Do not throw the batteries into fire.
- Do not leave dead or exhausted batteries in the remote control.
- Do not use different types of batteries together, or mix old and new batteries.
- If you do not use the remote control for a long period of time, remove the batteries to avoid possible damage from battery corrosion.
- If the remote control does not function correctly or if the operating range becomes reduced, replace all batteries with new ones.
- If battery leakage occurs, wipe the battery liquid from the battery compartment, then insert new batteries.
- The batteries should last about one year with normal use.

### Operating with the Remote Control

This section shows you how to use the remote control.

Point the remote control at the remote sensor and press the buttons.

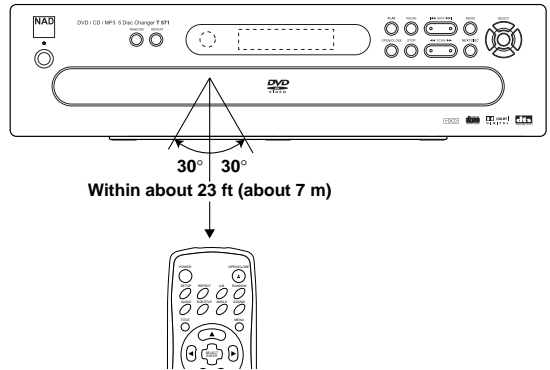

Distance: About 23 ft (7 m) from the front of the remote sensor

Angle: About 30° in each direction of the front of the remote sensor

- \* Do not expose the remote sensor of the DVD player to a strong light source such as direct sunlight or illumination. If you do so, you may not be able to operate the DVD player with the remote control.

#### Notes on the remote control

- Point the remote control at the remote sensor on the DVD player.
- Do not drop or give the remote control a shock.
- Do not leave the remote control near an extremely hot or humid place.
- Do not spill water or put anything wet on the remote control.
- Do not disassemble the remote control.

## Connecting to Surround Sound System

### Enjoying Dolby Digital Sound

You can enjoy the high quality dynamic sound of Dolby Digital, Dolby Pro Logic, and 2 Channel Digital Stereo.

#### Dolby Digital

Dolby Digital is the surround sound technology used in theaters showing the latest movies, and is now available to reproduce this realistic effect in the home. You can enjoy motion picture and live concert DVD video discs with this dynamic realistic sound by connecting the DVD player to a 5.1 channel receiver equipped with a Dolby Digital decoder or Dolby Digital processor.

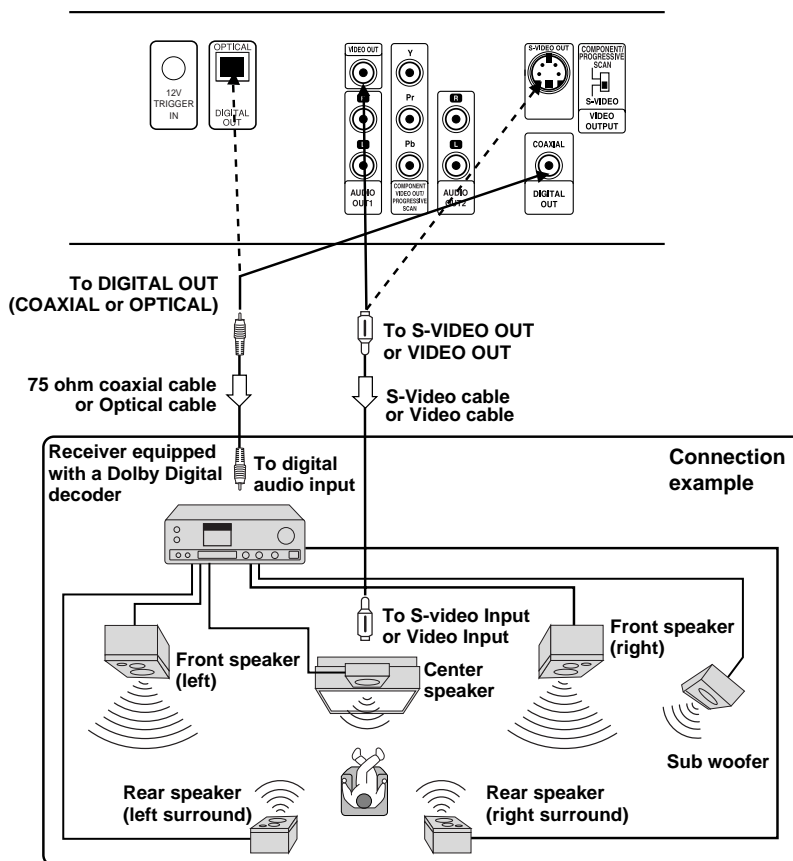

**To enjoy Dolby Digital sound from this DVD player you need the following:**

- DVD recorded in Dolby Digital
- 5.1 channel receiver equipped with a Dolby Digital decoder, or Dolby Digital processor and power receiver
- 5 speakers and 1 sub woofer

**To enjoy Dolby Digital sound**  
You need to select "Dolby Digital" on the SETUP menu.

\* Manufactured under license from Dolby Laboratories.  
"Dolby", "Pro Logic", and the double-D symbol are trademarks of Dolby Laboratories. Confidential Unpublished works. Copyright 1992-1997 Dolby Laboratories. All rights reserved.

#### Notes

- Refer to the owner's manual of your audio system for operating instructions.
- Before you connect the DVD player to other equipment, be sure to turn off the power and unplug all of the equipment from the wall outlet before making any connections.
- The output sound of the DVD player has a wide dynamic range. Be sure to adjust the receiver's volume to a moderate listening level. Otherwise, the speakers may be damaged by a sudden high volume sound.
- Turn off the receiver before you connect or disconnect the DVD player's power cord. If you leave the receiver power on, the speakers may be damaged.

Connecting to Surround Sound System (Cont'd)

Enjoying Dolby Pro Logic Surround Sound

**Dolby Pro Logic Surround**

You can still enjoy the excitement of Surround Sound even if your A/V receiver does not offer Dolby Digital decoding. If your A/V receiver has a Dolby Pro Logic decoder, refer to the following connection diagram.

Connect one or two rear speakers.  
 Note: The surround effect is greatly enhanced by using two surround speakers.

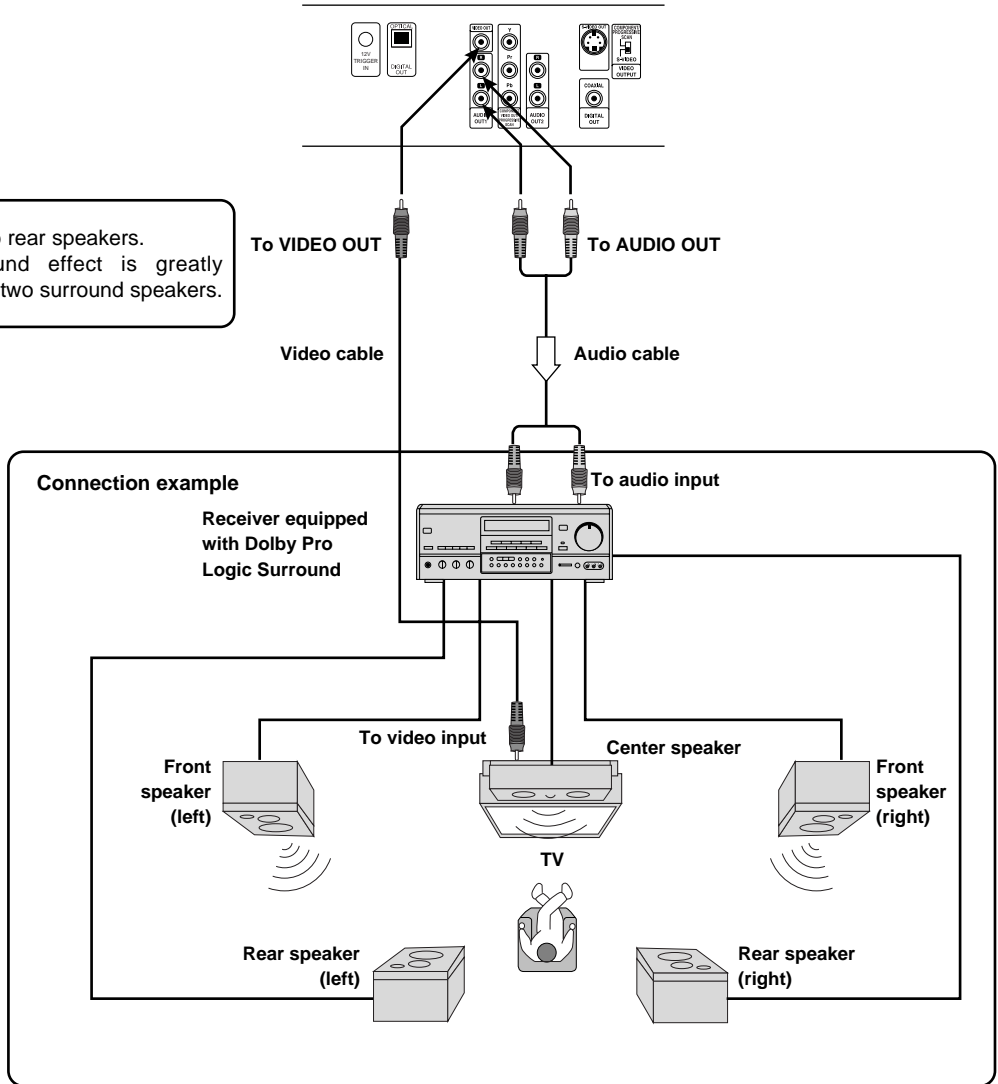

- **With a receiver equipped with Dolby Digital**  
 Connect the equipment the same way as described in "Enjoying Dolby Digital Sound" on the previous page. Refer to that receiver's owner's manual and set the receiver so you can enjoy Dolby Pro Logic Surround sound.

**Warning**

Do not set the Digital Audio Output of this DVD player to "Dolby Digital" unless you are connecting the DIGITAL OUT jack of this DVD player to an AV decoder that has the Dolby Digital decoding function. High volume sound may damage your hearing as well as the speakers (Refer to "Selecting Digital Audio Output" on page 25).

## Connecting to Surround Sound System (Cont'd)

### Enjoying 2 Channel Digital Stereo Sound

#### 2 Channel Digital Stereo

You can enjoy the dynamic sound of 2 Channel Digital Stereo by connecting this DVD player to a receiver equipped with a digital audio input and speaker system (right and left front speakers).

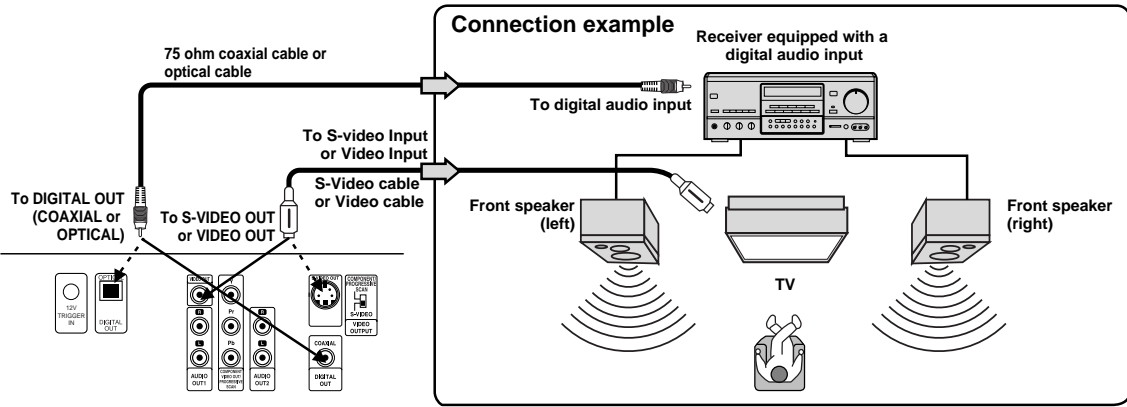

### Enjoying DTS Sound

- Your A/V Receiver or processor must be equipped with a DTS Decoder.
- The digital output (see selecting digital output page 25) must be set to "stream".
- The disc must have a DTS soundtrack.

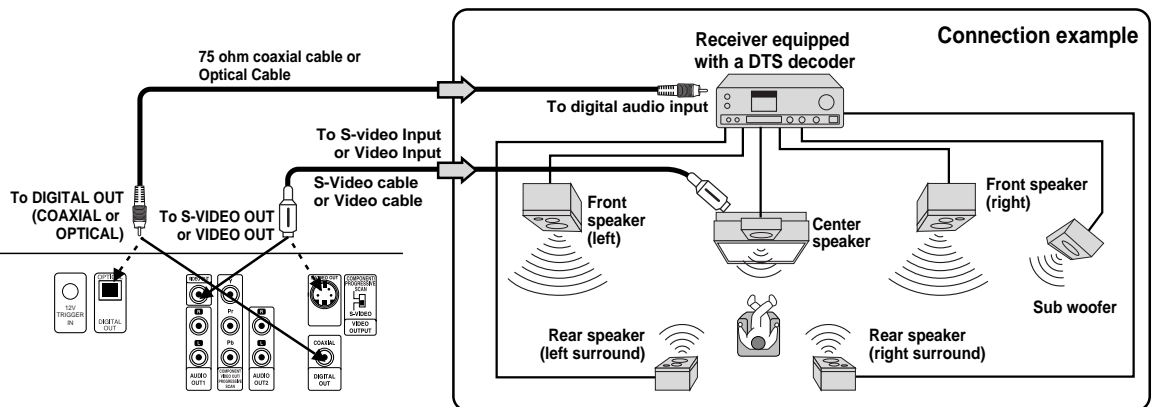

"DTS" and "DTS Digital Out" are trademarks of Digital Theater Systems, Inc.

#### Notes

- Refer to the owner's manual of your audio system for operating instructions.
- Before you connect the DVD player to other equipment, be sure to turn off the power and unplug all of the equipment from the wall outlet before making any connections.
- The output sound of the DVD player has a wide dynamic range. Be sure to adjust the receiver's volume to a moderate listening level. Otherwise, the speakers may be damaged by a sudden high volume sound.
- Turn off the receiver before you connect or disconnect the DVD player's power cord. If you leave the receiver power on, the speakers may be damaged.

## Connecting to an Stereo System

You can listen to the sound of audio CDs and DVD video discs in stereo.

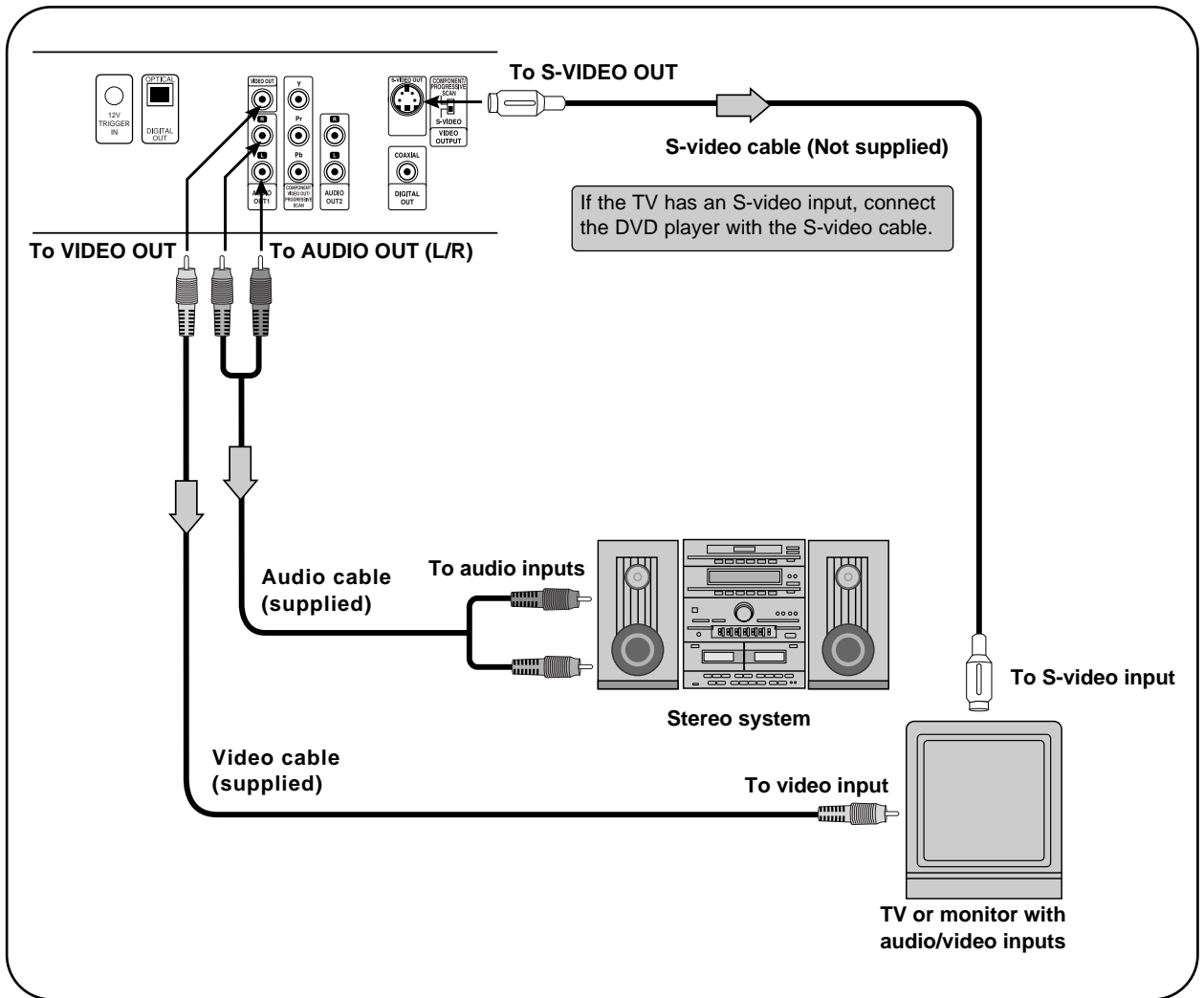

### Notes

- Refer to the owner's manual of your stereo system for operating instructions.
- Before you connect the DVD player to other equipment, be sure to turn off the power and unplug all of the equipment from the wall outlet before making any connections.
- If you place the DVD player near a tuner or radio, the radio broadcast sound might be distorted. In this case, move the DVD player away from the tuner and radio.
- The output sound of the DVD player has a wide dynamic range. Be sure to adjust the receiver's volume to a moderate listening level. Otherwise, the speakers may be damaged by a sudden high volume sound.
- Turn off the receiver before you connect or disconnect the DVD player's power cord. If you leave the receiver power on, the speakers may be damaged.

### Warning

Do not set the Digital Audio Output of this DVD player to "Dolby Digital" unless you are connecting the DIGITAL OUT jack of this DVD player to an AV decoder that has the Dolby Digital decoding function. High volume sound may damage your hearing as well as the speakers (Refer to "Selecting Digital Audio Output" on page 25).

## Connecting to a TV equipped with component video inputs

**PROGRESSIVE SCAN:** Some TVs or monitors are equipped with component video inputs that are capable of reproducing a progressively scanned video signal. Connecting to these inputs allows you to view the highest quality pictures with less flicker.

**COMPONENT VIDEO OUT:** Some TVs or monitors are equipped with component video inputs. Connecting to these inputs allows you to enjoy higher quality picture playback.

### ■ To switch the output signal (Progressive/Component)

Set the Progressive to "On" on the SETUP menu for Progressive signal, or set the Progressive to "Off" on the SETUP menu for Component video signal.

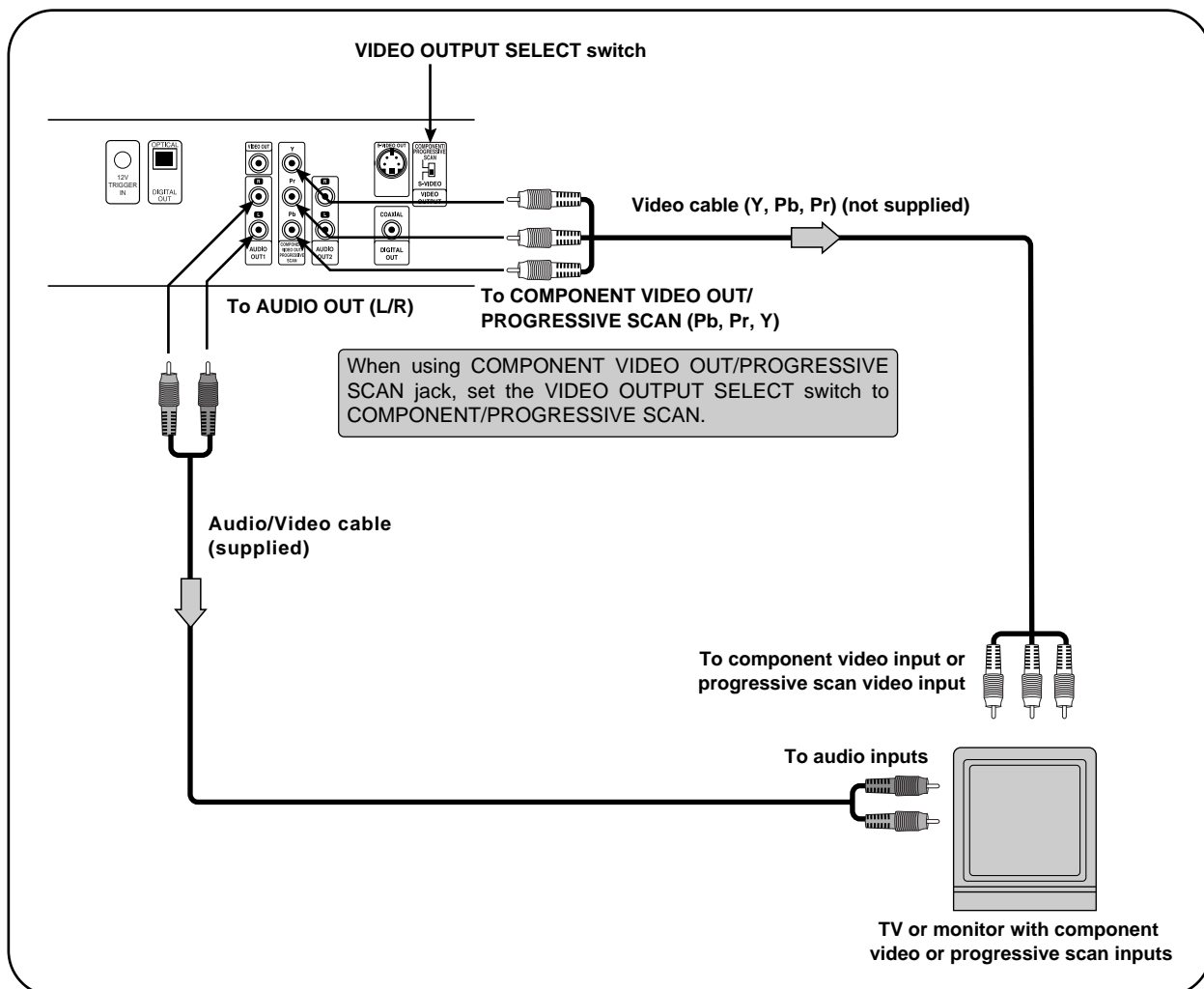

### Notes

- Refer to the owner's manual of your TV for TV operating instructions.
- Before you connect the DVD player to your TV, be sure to turn off the power and unplug both units from the wall outlet before making any connections.
- Actual labels for component video inputs may vary depending on the TV manufacturer. (ex. Y, -Y, B-Y or Y, Cb, Cr)
- In some TVs or monitors, the color levels of the playback picture may be reduced slightly or the tint may change. In such a case, adjust the TV or monitor for optimum performance.



## Connecting to a TV

Connect the DVD player to your TV.

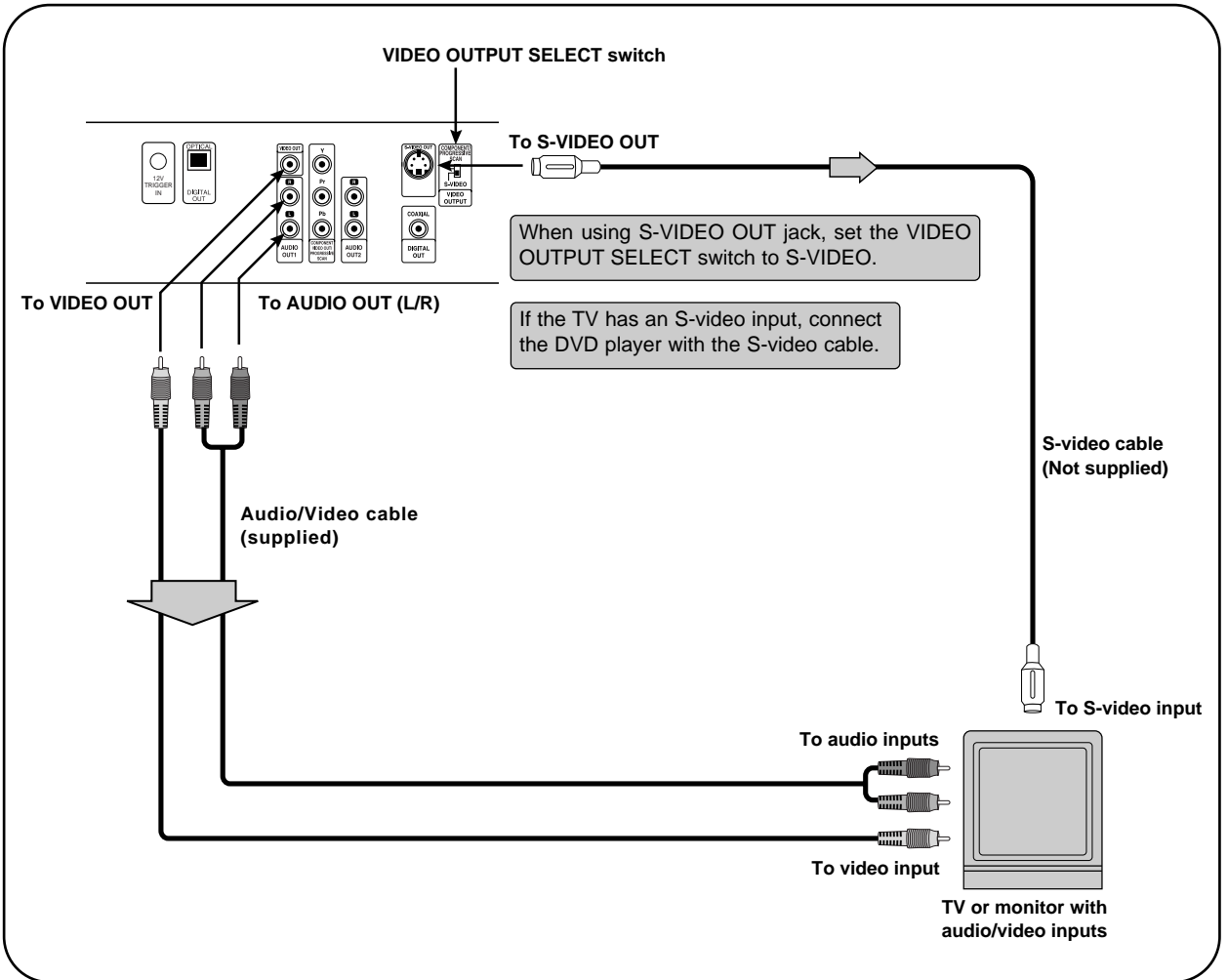

### Notes

- Refer to the owner's manual of your TV for TV operating instructions.
- Before you connect the DVD player to your TV, be sure to turn off the power and unplug both units from the wall outlet before making any connections.
- Connect the DVD player to your TV directly. If you connect the DVD player to a VCR, the playback picture will be distorted because DVD video discs are copy protected.

### Warning

Do not set the Digital Audio Output of this DVD player to "Dolby Digital" unless you are connecting the DIGITAL OUT jack of this DVD player to an AV decoder that has the Dolby Digital decoding function. High volume sound may damage your hearing as well as the speakers (Refer to "Selecting Digital Audio Output" on page 25).

## Selection of initial settings

Once the initial settings have been completed, the player can always be operated under the same conditions (especially with DVD discs). The settings will be retained in the memory until they are changed, even if the power is switched off.

## Selection of initial settings

- 1 Press **SETUP** in the stop or playback mode.  
The SETUP menu is displayed.



- 2 Press **▲/▼** to select the desired item.  
The screen will show the current setting for the selected item, and the alternate setting(s).

- Disc Audio (see page 19.)
- Disc Subtitle (see page 19.)
- Disc Menu (see page 19.)
- Rating (see page 20.)
- Password (see page 21.)
- TV Aspect (see page 22.)
- Menu Language (see page 23.)
- Progressive Scan (see page 24.)
- Digital Audio Output (see page 25.)
- Others (see page 26.)

- 3 Press **▶** and then **▲/▼** to select the desired setting and press **SELECT/ENTER**.

- Some items require additional steps. (See the respective page.)

When the alternate setting is selected the screen returns to the Initial Settings display.

### To exit SETUP menu

Press **SETUP**, **RETURN** or **PLAY**.

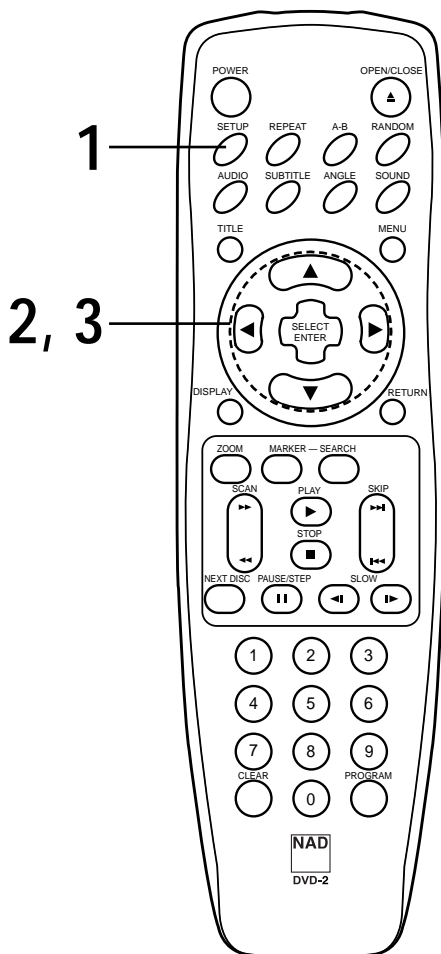



## Selecting disc languages

This is to select the audio soundtrack language, subtitle language and the language used in title menus or DVD menus which will always be used for every disc to be played back.

When you play back a DVD video disc, the DVD player automatically displays the pre-selected subtitle language if it is included on the disc.

**1** At the setup screen, press ▲/▼ to select “Disc Audio” and press ►.



**2** Press ▲/▼ to select the desired language and then press SELECT/ENTER.

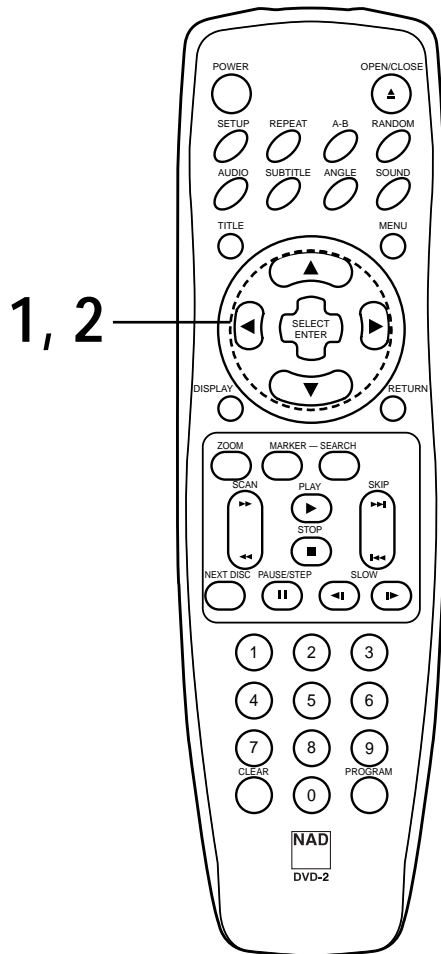

- Original** : The original language of each disc will be selected.
- English** : The English will be Selected.
- Other** : Another language can be selected. You can input 4-number language code. (Refer to the language codes on page 27.)

The “Disc Subtitle” and “Disc Menu” are selected by the same method.

### Note

- If the language selected is not available on the disc, the original language designated by each disc will be selected.



## Selecting Parental Control Rating Levels and Password

This is to prohibit the playing of specified DVDs which are unsuitable for children.

- Some DVD discs contain a restriction level which enables parents to remove scenes or prevent playback of discs by children. DVD players are equipped with a password designed to prevent children from changing the level.

### Selecting rating level (DVD only)

- At the SETUP screen, press ▲/▼ to select "Rating" and press ►.

Disc Audio	8
Disc Subtitle	7
Disc Menu	6
Rating	5
Password	4
TV Aspect	3
Menu Language	2
Progressive Scan	1
Digital Audio Output	►Unlock
Others	

- Press ▲/▼ to select the desired level and press SELECT/ENTER.

Disc Audio	8 Blocked
Disc Subtitle	7 Blocked
Disc Menu	√6
Rating	5
Password	4
TV Aspect	3
Menu Language	2
Progressive Scan	1
Digital Audio Output	Unlock
Others	

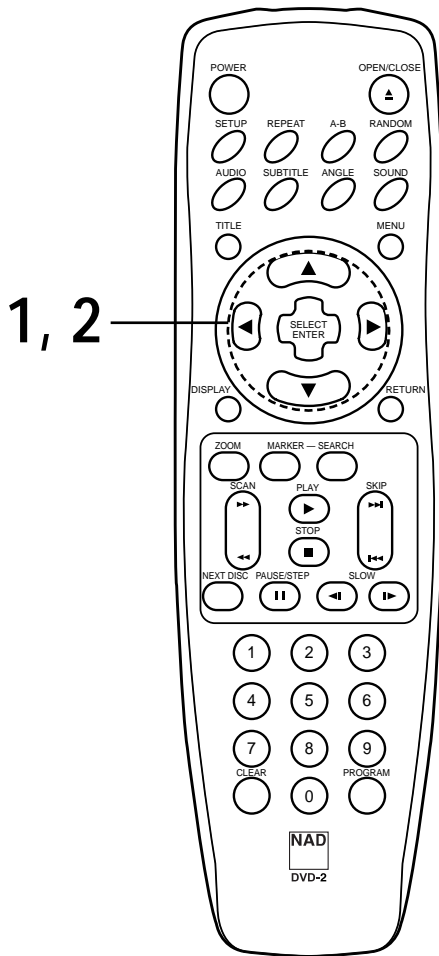

You cannot play DVD video discs rated higher than the level you selected unless you cancel the parental lock function. For example, when you select level 7, discs rated higher than level 7 are blocked and cannot be played.

The parent lock level is equivalent to the following USA movie ratings.

- Level 7: NC-17    Level 6: R    Level 4: PG 13
- Level 3: PG    Level 1: G

- Some titles do not match with the rating level described as above.

If you change the level and enter a password, playback of all DVDs with ratings higher than your selection will be blocked, unless the correct password is entered again. For example: if you change the level to "5", the DVD player will not play discs with ratings of "6", "7" or "8" unless the correct password is entered on the remote control.

Selecting Parental Control Rating Levels and Password (Cont'd)



**Setting your password (DVD only)**

If you change the rating level to "7" or lower, you must enter a 4-number "password" to prevent playback of discs with higher ratings.

- 1 At the SETUP screen, press ▼ to select "Password" and press ►.

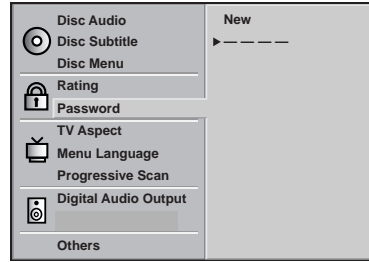

- 2 Input a 4-number password and press SELECT/ENTER.

Example : 1234

Do not forget your password.

- 3 Input the 4-number password again and press SELECT/ENTER to verify.

Setting is complete.

- The rating is locked. Any disc whose rating is higher than the setting, cannot be played back unless the correct password is entered.

**To change/clear memorized password**

- 1 At the SETUP screen, press ▼ to select "Password" and press ►.

- 2 Input your password and press SELECT/ENTER.



- 3 To change or clear your password, press ▲/▼ to select the "Change" or "Clear" and press SELECT/ENTER.

To change the rating level/password, follow the steps on page 20-21 again.

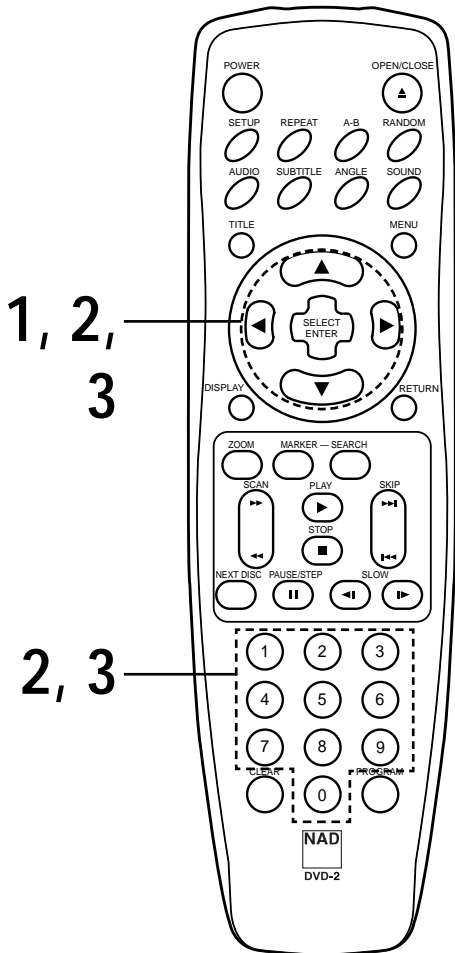

**To clear your 4-number password**

If you forget your password, to clear the current password, follow the procedure below.

- 1 Press **SETUP**.  
The SETUP menu is displayed.
- 2 Enter 6-digit number "210499" by pressing number buttons.  
The 4-number password is cleared. "P CLR" appears on the display.
- 3 Enter a new password.  
Refer to "Setting your password" section on the right.

## Selecting TV Aspect



Select the appropriate screen type according to your TV set; conventional size screen (4:3) or wide-screen (16:9).

**1** At the **SETUP** screen, press **▲/▼** to select **"TV Aspect"** and press **▶**.

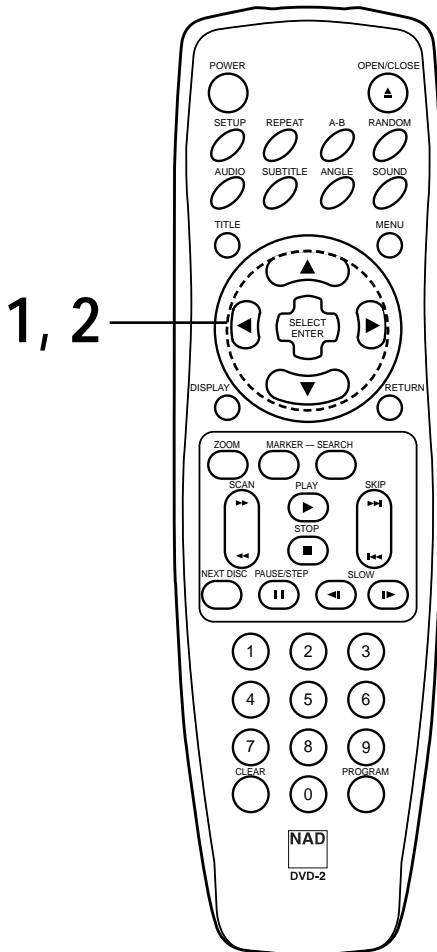
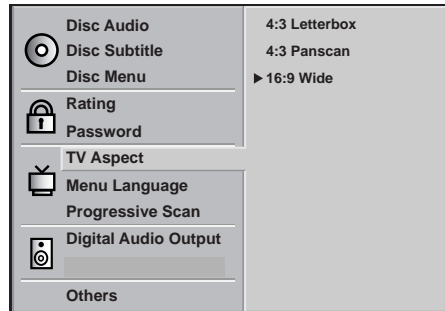

**2** Press **▲/▼** to select the desired Aspect and press **SELECT/ENTER**.

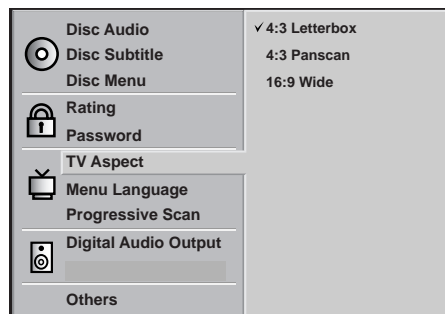

**4:3 Letterbox** : The video material not formatted in the Pan & Scan style is played back in the letterbox style (black bands appear at top and bottom of screen).

**4:3 Panscan** : Select when a conventional TV set is connected. The video material formatted in the Pan & Scan style is played back in that style (the left and right edges are cut off).

**16:9 Wide** : Select when a wide-screen TV set is connected. Played in "FULL" size. (Setting the wide-screen TV to "FULL" mode is also necessary.)

\* Each screen shows an example when the video material for a wide-screen is played. (This setting does not affect the video material for conventional size.)



4:3 Letterbox

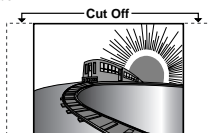

4:3 Panscan



16:9 Wide

## Selecting Menu Language



Selects language for SETUP menus and displays on the TV.

- 1 At the SETUP screen, press ▲/▼ to select "Menu Language" and press ►.



1, 2

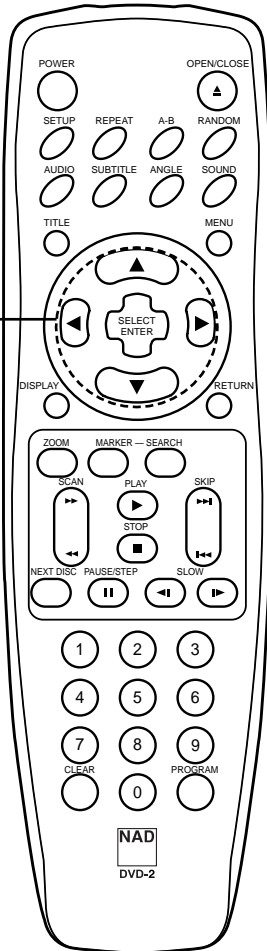

- 2 Press ▲/▼ to select the desired Language and press SELECT/ENTER.





## Selecting Progressive Scan

If your television is high-definition or “digital ready” television, you may take advantage of the DVD Player’s progressive scan output for the highest video resolution possible. Make the component video connections as shown on page 16 or you may connect the component video jacks directly to the component video or HD component inputs on your TV or monitor. Once the connection is made, the progressive scan circuitry must be activated by changing the SETUP menu.

**Note:** The progressive scan capability is not operational with standard analog component video connections.

**1** At the SETUP screen, press ▲/▼ to select “Progressive Scan” and press ►.

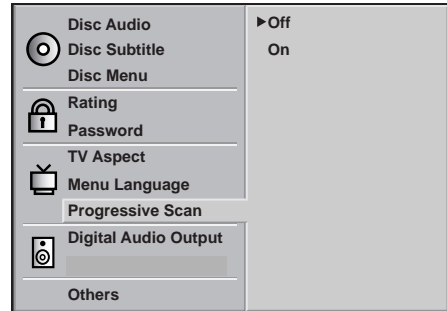

**2** Press ▲/▼ to select the desired Progressive mode (On or Off) and press SELECT/ENTER.

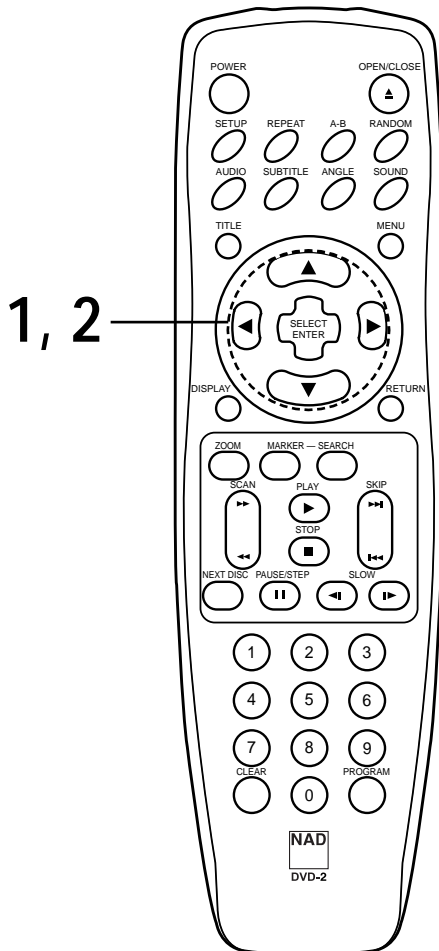
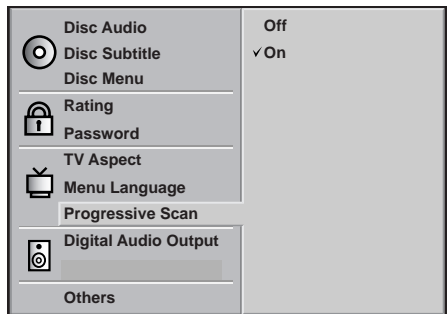

- Off:** If you are using the COMPONENT VIDEO OUT jacks, but are connecting the DVD player to a standard (analog) television, set the Progressive mode to “Off”.
- On:** If you are using the COMPONENT VIDEO OUT jacks for connection to a TV that is compatible with a progressive scan signal, set the Progressive mode to “On”.

### Notes

- The Progressive function only works when VIDEO OUTPUT SELECT switch on the rear panel is set to COMPONENT/ PROGRESSIVE SCAN.

### Warning

Once the setting for progressive scan output is entered, an image will only be visible on a progressive scan compatible video display. If you change the setting to “On” in error, you must reset the unit by first pressing the STOP to stop any disc that is playing. Next, press the STOP again and hold it for five seconds before releasing it. The video output will be restored to the standard setting, and a picture will once again be visible on a conventional analog display.





## Selecting Digital Audio Output

Each DVD disc has a variety of audio output options. Set the player's Digital Audio Output according to the type of audio system you use.

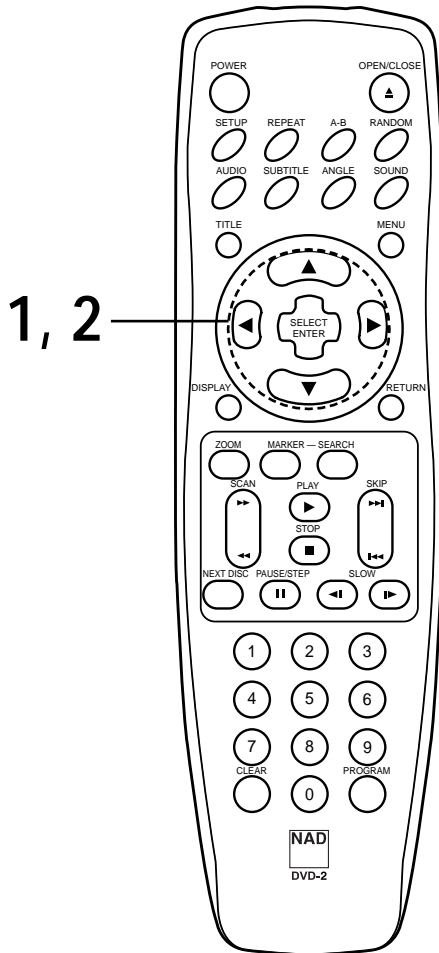

**1** At the **SETUP** screen, press **▲/▼** to select **Digital Audio Output** and press **▶**.

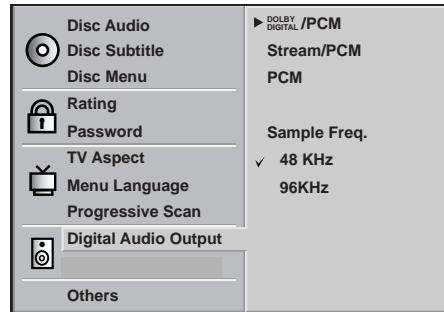

**2** Press **▲/▼** to select the desired output and press **SELECT/ENTER**.

You can select Digital Audio Output or Sampling Frequency item by pressing **SELECT/ENTER**.

### ■ Digital Audio Output

**DOLBY DIGITAL/PCM:** Select "DOLBY DIGITAL/PCM" if an active digital output is supplied to a Dolby Digital decoder, (or an amplifier or other equipment with Dolby Digital decoder).

**Stream/PCM:** Select "Stream/PCM" if an active digital output is supplied to an amplifier or other equipment with DTS decoder, Dolby Digital decoder and MPEG decoder.

**PCM:** Select "PCM" if an active digital output is supplied to an amplifier or other equipment with linear PCM only (or MD recorder or DAT deck).

### ■ Sampling Frequency

To change the Sample Frequency setting, first select the desired digital audio output type as indicated above. If your A/V receiver or surround processor is NOT capable of handling 96kHz signals, select the 48kHz option. When this choice is made, this unit will automatically convert any 96kHz signals to a 48kHz output so that your system is capable of decoding them.

If your A/V receiver or surround processor is capable of handling 96kHz signals, select the 96kHz option. When this choice is made, this unit will pass each type of signal through without any further processing.

Playback Disc	OUTPUT		
	Stream/PCM	Dolby Digital/PCM	PCM only
96 kHz Linear PCM DVD	PCM	PCM	PCM
DTS DVD	DTS bit Stream	DTS bit Stream	DTS bit Stream
Dolby Digital DVD	Dolby Digital bit Stream	Dolby Digital bit Stream	PCM
MPEG DVD	MPEG bit Stream	PCM	PCM
Audio CD	PCM	PCM	PCM
DTS Audio CD	DTS bit Stream	DTS bit Stream	DTS bit Stream

### Notes

- If an active digital audio output signal is supplied to a receiver or other equipment without a corresponding digital decoding capability, a very loud noise may be produced which could permanently damage the speakers.
- The DTS DVD disc sound is played back only when the DVD player is connected to a receiver with a DTS decoder.

## Others



The DRC settings can be changed.

- At the SETUP screen, press ▲/▼ to select "Others" and press ►.

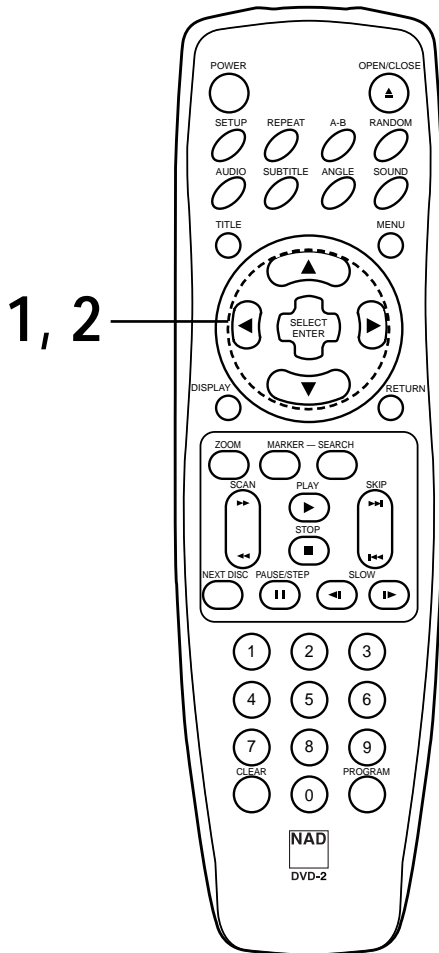

- Press ▲/▼ to select the desired items and press SELECT/ENTER.  
The setting of the selected item are changed between On and Off.

- DRC (Dynamic Range Compression) On/Off**  
**On:** Select this option to turn on the Dynamic Range Compression circuitry so that the dialogue remains clear even at low volume levels.  
**Off:** Select this option to turn off the Dynamic Range Compression and have the soundtrack presented exactly as it was created.

#### Notes

- The DRC function works only during playback of Dolby Digital recorded discs.
- The level of Dynamic Range Compression may differ depending on the DVD disc.

#### About DRC (Dynamic Range Compression)

With the DVD format you have the opportunity to hear a program's soundtrack in the most accurate and realistic presentation possible, thanks to the use of digital audio technology. However, in certain instances you may wish to slightly compress the dynamic range of the audio output (the difference between the loudest sounds and the quietest ones) so that you may listen to a movie at a lower volume without losing dialogue intelligibility.

## Table of Languages and Their Abbreviations



Enter the appropriate code number for the initial settings "Audio", "Subtitle" and/or "Menu" (See page 19).

Code	Language	Code	Language	Code	Language	Code	Language
6565	Afar	7079	Faroese	7678	Lingala	8375	Slovak
6566	Abkhazian	7082	French	7679	Laothian	8376	Slovenian
6570	Afrikaans	7089	Frisian	7684	Lithuanian	8377	Samoan
6577	Ameharic	7165	Irish	7686	Latvian, Lettish	8378	Shona
6582	Arabic	7168	Scots Gaelic	7771	Malagasy	8379	Somali
6583	Assamese	7176	Galician	7773	Maori	8381	Albanian
6588	Aymara	7178	Guarani	7775	Macedonian	8382	Serbian
6590	Azerbaijani	7185	Gujarati	7776	Malayalam	8385	Sundanese
6665	Bashkir	7265	Hausa	7778	Mongolian	8386	Swedish
6669	Byelorussian	7273	Hindi	7779	Moldavian	8387	Swahili
6671	Bulgarian	7282	Croatian	7782	Marathi	8465	Tamil
6672	Bihari	7285	Hungarian	7783	Malay	8469	Telugu
6678	Bengali; Bangla	7289	Armenian	7784	Maltese	8471	Tajik
6679	Tibetan	7365	Interlingua	7789	Burmese	8472	Thai
6682	Breton	7378	Indonesian	7865	Nauru	8473	Tigrinya
6765	Catalan	7383	Icelandic	7869	Nepali	8475	Turkmen
6779	Corsican	7384	Italian	7876	Dutch	8476	Tagalog
6783	Czech	7387	Hebrew	7879	Norwegian	8479	Tonga
6789	Welsh	7465	Japanese	7982	Oriya	8482	Turkish
6865	Danish	7473	Yiddish	8065	Panjabi	8484	Tatar
6869	German	7487	Javanese	8076	Polish	8487	Twi
6890	Bhutani	7565	Georgian	8083	Pashto, Pushto	8575	Ukrainian
6976	Greek	7575	Kazakh	8084	Portuguese	8582	Urdu
6978	English	7576	Greenlandic	8185	Quechua	8590	Uzbek
6979	Esperanto	7577	Cambodian	8277	Rhaeto-Romance	8673	Vietnamese
6983	Spanish	7578	Kannada	8279	Rumanian	8679	Volapük
6984	Estonian	7579	Korean	8285	Russian	8779	Wolof
6985	Basque	7583	Kashmiri	8365	Sanskrit	8872	Xhosa
7065	Persian	7585	Kurdish	8368	Sindhi	8979	Yoruba
7073	Finnish	7589	Kirghiz	8372	Serbo-Croatian	9072	Chinese
7074	Fiji	7665	Latin	8373	Singhalese	9085	Zulu

## Basic Playback



This section shows you the basics on how to play back a DVD video disc.

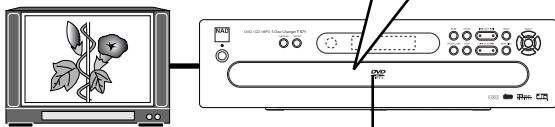
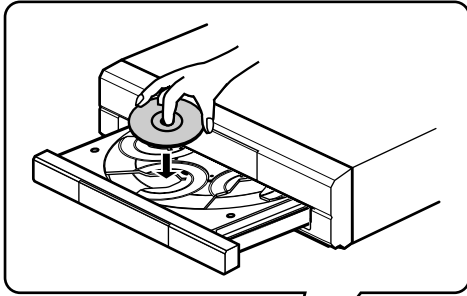

3

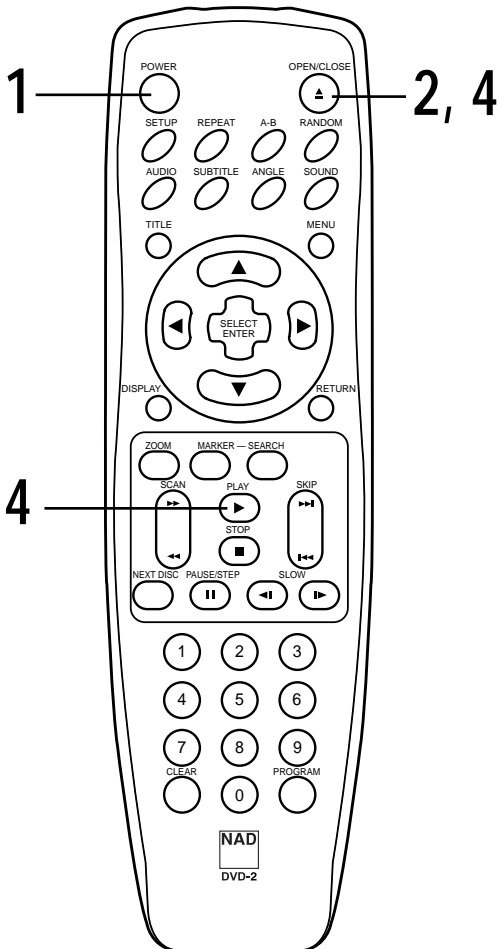

### Preparations

- When you want to play back DVD video discs, turn on the TV and select the video input source connected to the DVD player.
- When you want to enjoy the sound of DVD video discs or audio CDs from the audio system, turn on the audio system and select the input source connected to the DVD player.
- For connection details, see pages 12 through 17.
- Set the playback picture size according to the aspect ratio of the connected TV via the SETUP menu (TV Aspect).
- If you do not have the necessary equipment to enjoy Dolby Digital sound, set the Digital Audio Output (via the SETUP menu) to "PCM".

### 1 Press POWER.

The DVD player turns on and the power indicator lights.

### 2 Press OPEN/CLOSE.

The disc tray opens.

- You can open the disc tray by pressing this button even if the DVD player is in standby mode.

### 3 Place a disc on the disc tray with the playback side down.

- There are two different disc sizes. Place the disc in the correct guide on the disc tray. If the disc is out of the guide, it may damage the disc and cause the DVD player to malfunction.
- Do not place anything except 3" discs or 5" discs on the disc tray.
- Discs can be loaded one at a time by pressing NEXT DISC to rotate the carousel.

**Caution:** Do not touch the loading drawer and carousel while they are in motion, and do not attempt to rotate the carousel by hand; doing so could result in incorrect operation of the player and/or damage to the discs.

### 4 Press OPEN/CLOSE or PLAY to close the loading drawer.

The disc on the tray 1 is ready to be played back. Playback may begin automatically depending on the disc.

If no disc is loaded on disc tray 1, select another disc by following step 5.

- Do not close the loading drawer by hand.
- If the disc is placed in upside down (and it is a single-sided disc), "NO DISC" or "DISC ERROR" appears on the TV screen.



Operating status indicator

- If you insert an audio CD, the CD indicator lights up on the display. The title number does not appear.
- After playing back all of the chapters in the title, the DVD player automatically stops and returns to the menu screen.

Basic Playback (Cont'd)

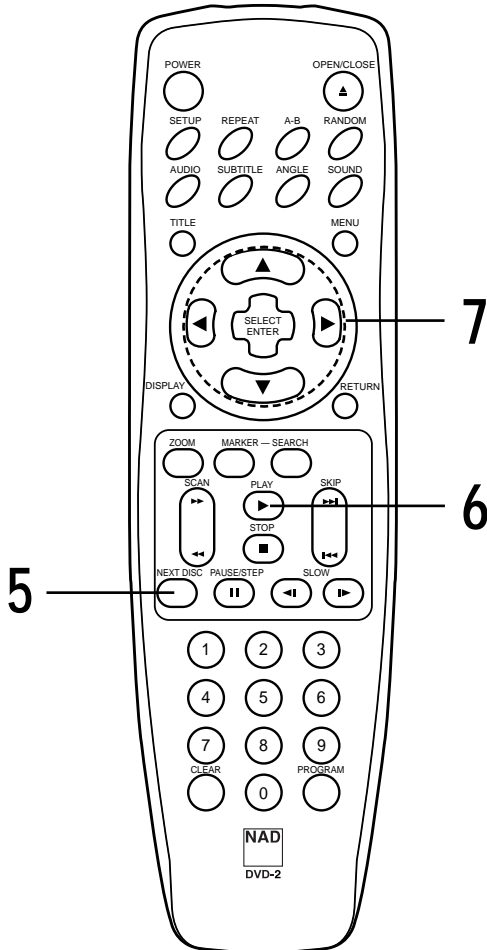

**5** If you want to select another disc, press **NEXT DISC** once or more.  
 Also you can select a disc in the DVD player directly by using the remote control, press NEXT DISC and then press a number button (1-5) on the remote control within one second.

**6** Press **PLAY** to begin playback.  
 Playback begins.  
 You can skip this step if the disc is already playing automatically.

**The menu screen appears on the TV screen.**  
 In the case of interactive DVDs with playback, a menu screen appears on the TV screen. Perform the following steps:

**7** Press **▲/▼/◀/▶** and press **SELECT/ENTER**, or press the numeric button(s), to select the desired item.  
 Playback of the selected item begins.

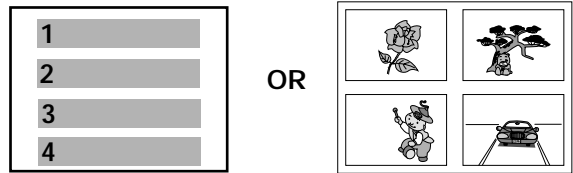

*Example of interactive DVD On-Screen Menu*

- For further information, refer to the disc jacket of the disc you are playing.

**After operation**

When the unit is not in use, remove the disc and press **POWER** to turn off the DVD player.

**Notes**

- Do not move the DVD player during playback. Doing so may damage the disc and the DVD player.
- Use the **OPEN/CLOSE** button on the remote control or DVD player to open and close the disc tray. Do not push the disc tray while it is moving. Doing so may cause the DVD player to malfunction.
- Do not push up the disc tray or put any objects other than discs on the disc tray. Doing so may cause the DVD video player to malfunction.
- Keep your fingers well clear of the disc tray as it is closing. Be especially careful with children's fingers around the closing disc tray as there is a risk of personal injury.
- When "⊘" appears on the TV screen while a button is pressed, it means that this function is not available on the disc you are playing.
- Depending on the DVD disc, some operations may be different or restricted. Refer to the jacket or case of the disc you are playing.

## Basic Playback (Cont'd)



## Stopping Play

Press STOP during playback.

## Resume Play

- When play is stopped, the unit records the point where STOP was pressed (RESUME function). Press PLAY and play will resume from this point.

## Notes

- This operation works only with discs for which the elapsed playing time appears in the DVD display window during stop.
- Resume function will be cleared when the STOP is pressed in the STOP mode.
- The Resume function may not be available on some DVD discs.

## Last Scene Memory

This player memorizes last scene for the last disc you have watched. Settings remain in memory even if you remove the disc from the player or switch off the player. If you load a disc that has its settings memorized, Latest Stop Position is automatically recalled.

## Notes

- Settings are stored in memory for use any time.
- Switching of the audio mode, etc., is automatic on some discs.
- This player does not memorize if you switch off the player when a DVD or title menu appears on the TV screen.
- The last scene memory function will be cleared when the STOP is pressed in the STOP mode.

## Screen Saver

The screen saver is useful to prevent your display from becoming damaged.

The screen saver picture appears when you leave the DVD player in stop mode for about 5 minutes.

## Automatic power off function

After the Screen Saver has been engaged for about 5 minutes, the DVD player will automatically turn itself off.

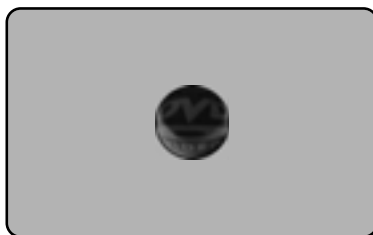
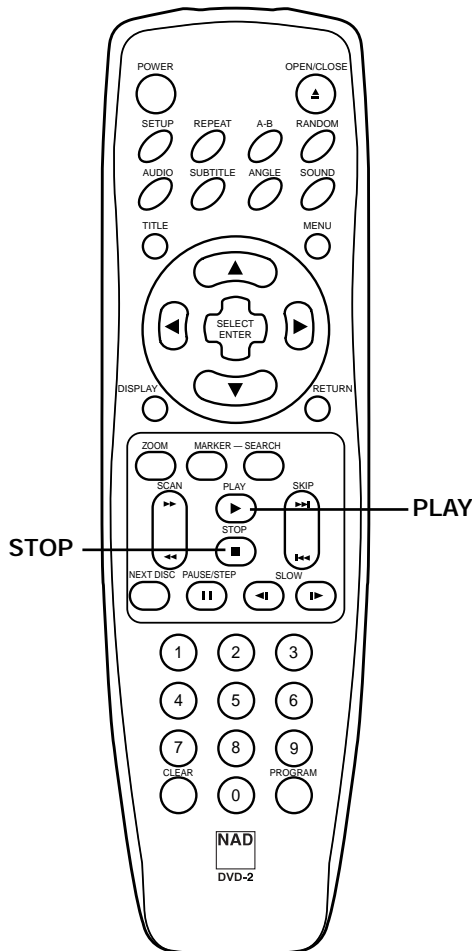

Screen Saver

Basic Playback (Cont'd)

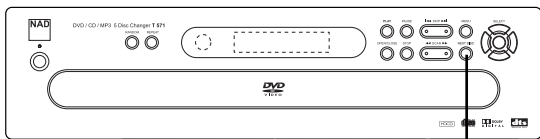

NEXT DISC

Skipping Discs

Press NEXT DISC during playback or in the stop mode.

- Each time the button is pressed, the next disc tray is selected.

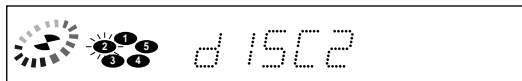
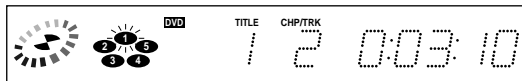

Notes

- When the NEXT DISC is pressed during playback or in the stop mode, the disc tray advances to the next disc.
- If there is no disc on the selected disc tray, the disc tray of the next number will be selected.

Exchanging the Disc and Starting Playback

- 1 Press OPEN/CLOSE during playback or in the stop mode.

Play is stopped (if pressed during playback), the loading drawer opens and the disc tray which was in the play position comes to the center position.

- 2 Exchange the disc in the center position.

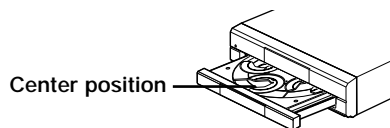

- 3 Press OPEN/CLOSE or PLAY again. The loading drawer closes, the disc tray returns to the play position and playback begins from the new disc.

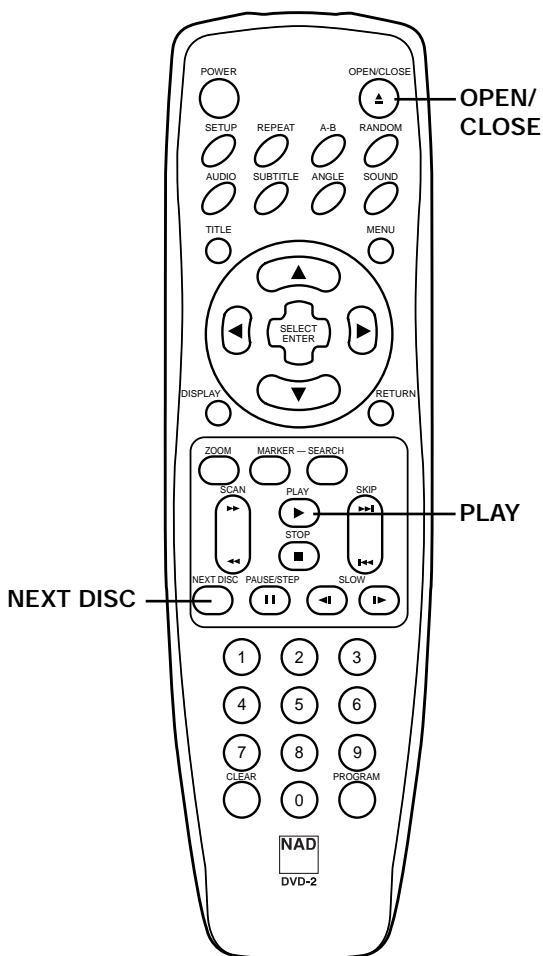



## Special Playback

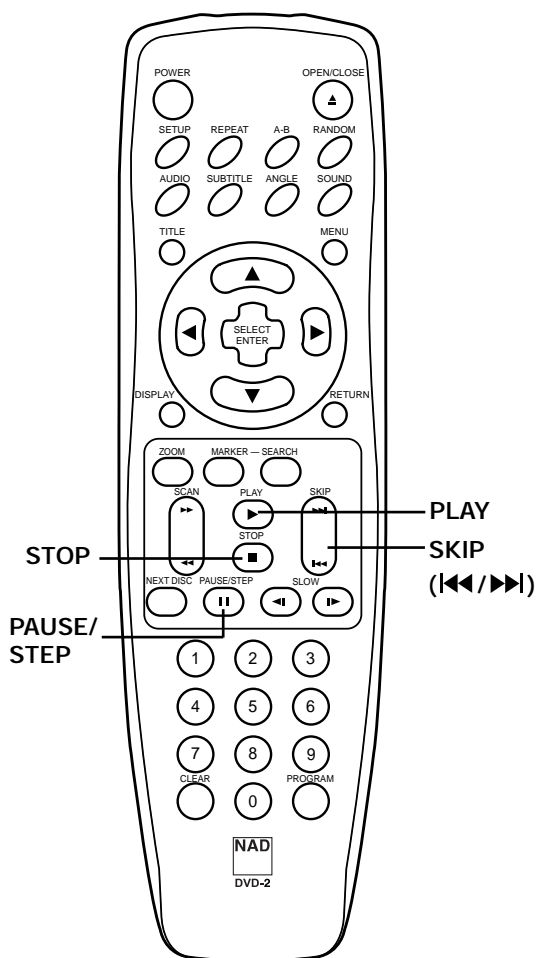

### Still Picture (Pause)

Press **PAUSE/STEP** during playback.

- DVD  
The player will be placed in the still picture mode.
- CD  
The player will be placed in the pause mode.

### Frame Advance (DVD only)

Press **PAUSE/STEP** during still playback.

(Each time you press PAUSE/STEP, the picture advances one frame)

To resume normal playback, press **PLAY**.

### Skipping chapters and tracks forward or back

**Skipping forward**

Press **SKIP** **▶▶** during playback.

A chapter (DVD) or a track (CD) is skipped each time the button is pressed.

**Skipping back**

Press **SKIP** **◀◀** during playback.

- When the button is pressed once midway through a chapter/track, the player returns to the start of that chapter/track. When it is pressed again, a chapter/track is skipped each time the button is pressed.

### How To Set The Video Mode

- With certain DVD disc, the playback picture is flickering or Dot Crawl is shown on straight lines. That means Vertical interpolation or De-interlace is not perfectly matched with DVD disc. In that case, the picture quality can be improved with changing video mode.
- To change the video mode, press and hold **DISPLAY** button on the remote control about 3 seconds during playback of DVD disc. Changed video mode number is displayed on the TV screen. Check whether video quality is improved. You can repeat above procedure until desired picture quality appears.
- Procedure of video mode is changed;  
MODE2 → MODE3 → MODE4 → MODE5 → MODE1.
- If you turn off the the power, the video mode will be back to initial state (Auto).

### HDCD Playback

HDCD is a process that increases the fidelity of both specially encoded HDCD discs and standard CD audio discs. When an HDCD-encoded disc is playing, the special decoder is automatically activated and the HDCD Indicator lights. No user intervention is required.

To enjoy the benefits of HDCD, your DVD Player must be connected to your A/V receiver via the Analog Audio Outputs. However, if your A/V receiver or surround processor is equipped with built-in HDCD decoding, you may also use a Coaxial or Optical digital audio connection so that the HDCD processing is done there.



Special Playback (Cont'd)



You can play back discs at various speeds.

To Scan at fast forward or fast reverse playback.

Press the SCAN ◀◀ or ▶▶ button during playback.

[TV screen]



- The speed of advance (reverse) is relatively slow at first. When the button is pressed again, the speed becomes faster. (Each time the button is pressed, the speed increases up to 4 steps (DVD) or 3 steps (CD).)
- The speed will be retained even after the button is released.

To return to normal playback, press PLAY.

Note

- The DVD player does not play back sound during the high speed reverse and forward playback of DVD video discs. However, the DVD player plays back sound during fast forward or fast reverse playback of audio CDs.

Playing in slow-motion (DVD only)

Press SLOW ◀◀ or ▶▶ during playback.

The playback speed becomes 1/16 of the normal speed.

[TV screen]



- The speed of slow-motion is slow at first. When the button is pressed again, the speed becomes faster. (Each time the button is pressed, the speed increase up to 4 steps.)
- The speed will be retained even after the button is released.

To return to normal playback, press PLAY.

Notes

- The sound is muted during slow-motion playback.
- Subtitles do not appear on the screen during slow motion playback.
- The SLOW buttons do not work with Audio CDs.

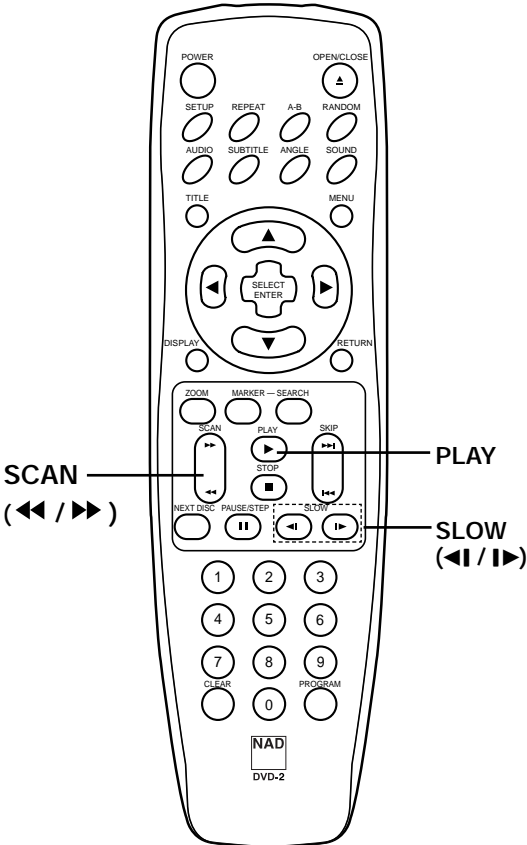

## General Information about GUI menu icons



This unit features GUI Menu Icons showing disc information (title/chapter/track number, elapsed playing time, audio/subtitle language, angle, and sound) and player information (repeat play, play mode, marker, etc.). Some icons only show the indicated information. Other icons allow the settings to be changed.

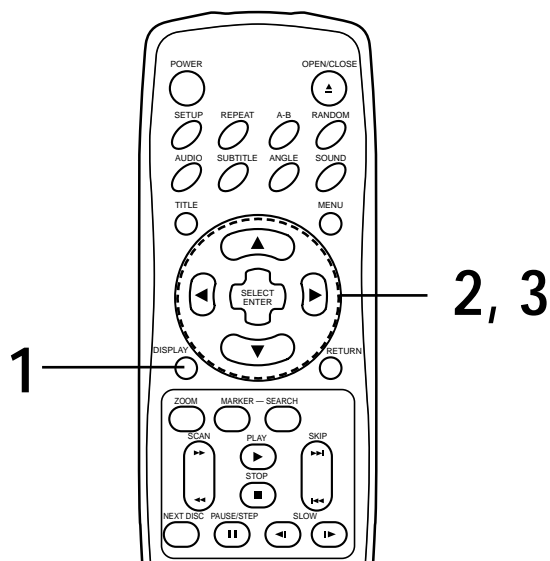

## Common procedures

- 1** Press **DISPLAY** during playback.
  - Title function can be accessed from the stop mode.
- 2** Press **▲/▼** to select the desired item.
  - The current selected item is indicated by a yellow frame on its GUI menu icons.
- 3** Press **◀/▶** to select the desired setting.
  - When numbers are displayed (e.g. title number), the numeric buttons can also be used for setting instead of **◀/▶**.
  - For some functions, the setting will be registered immediately; for others, **SELECT/ENTER** must be pressed.

To clear the GUI Menu Icons, press **DISPLAY** again.

### Examples of GUI Menu Icons.

(The screens may differ depending on the disc contents.)



(DVD GUI)

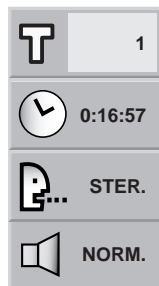

(CD GUI)



(DVD or CD GUI)

## Detailed description of each GUI menu icon



You can view information about a disc and its operational status on the TV screen.

Press DISPLAY during playback.

[TV screen] DVD GUI



**FUNCTION**  
(Press ▲/▼ to select desired item)

**SELECTION METHOD**

To show the current title number and to jump to the desired title number	◀/▶, or Numeric SELECT/ENTER
To show the current chapter number and to jump to the desired chapter number	◀/▶, or Numeric SELECT/ENTER SKIP
To show the elapsed time and directly select scenes by the desired time.	Numeric SELECT/ENTER
To show the current audio soundtrack language, encoding method, channel number and to change the settings.	◀/▶, AUDIO
To show the current subtitles language and to change the setting.	◀/▶, SUBTITLE
To show the current angle number and to change the angle.	◀/▶, ANGLE
To show the current sound (NORMAL or 3D SURROUND) and to change the setting.	◀/▶, SOUND

Press DISPLAY during playback.

[TV screen] CD GUI

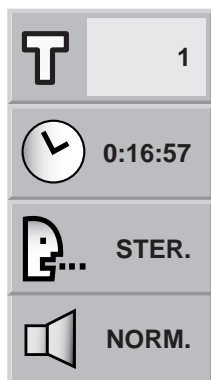

**FUNCTION**  
(Press ▲/▼ to select desired item)

**SELECTION METHOD**

To show the current track number and to jump to the desired track number	◀/▶, or Numeric SELECT/ENTER SKIP
To show the elapsed time. (Display only)	—
To show the current audio (STEREO, LEFT, RIGHT) and to select to the desired audio channel.	◀/▶, AUDIO
To show the current sound (NORMAL or 3D SURROUND) and to change the setting.	◀/▶, SOUND

#### Note

- Some DVD discs may not provide all of the above GUI menu icons.



## Using a title menu

Some movie discs may contain two or more titles. If the disc has a title menu recorded on it, the TITLE button can be used to select the movie title. (The details of operation differ depending on the disc used.)

- Selecting a title may not be possible on certain DVD discs.

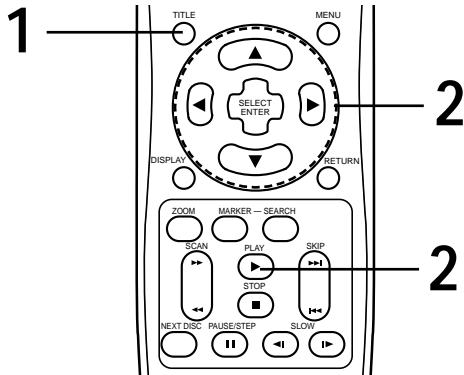

- 1 Press TITLE.**  
A list of the titles on the disc is displayed.

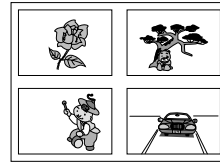

Pressing TITLE again to resume play from the scene when TITLE was first pressed.

- Resume play may not be possible on certain discs.

- 2 Press ▲/▼/◀/▶ and press SELECT/ENTER or PLAY, or press the numeric button(s), to select desired title.**

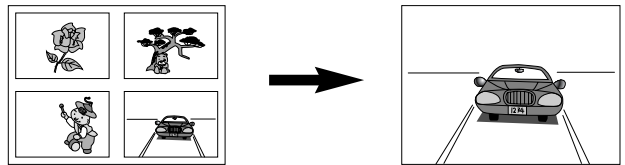

The selected title now starts playing.

## Using a DVD menu



Some DVDs have unique menu structures called DVD menus. For example, DVDs programmed with complex contents provide guide menus, and those recorded with various languages provide menus for audio and subtitle language. Although the DVD menu's contents and operation differ from disc to disc, the following explains the basic operation when this feature is used.

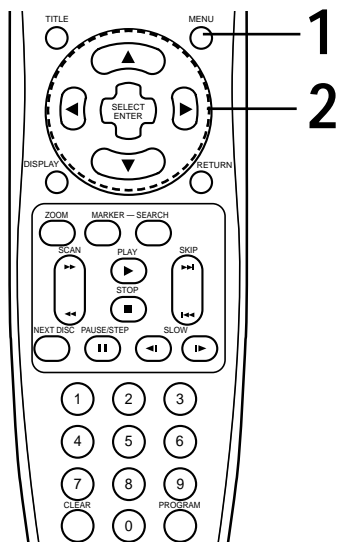

- 1 Press MENU during play.**  
The DVD menu available on the disc is now displayed.

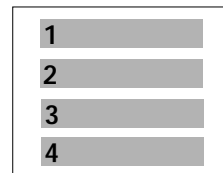

Pressing MENU again resumes play from the scene when MENU was first pressed.

- Resume play may not be possible on certain discs.

- 2 Press ▲/▼/◀/▶ and press SELECT/ENTER, or press the numeric button(s), to select desired item.**

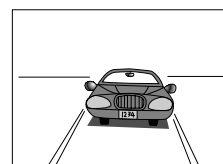

The selected item is now executed.

## Changing subtitle language



It is possible to change the subtitle language to a different language from the one selected at the initial settings. (See page 19 for further info.)

This operation works only with discs on which multiple subtitle languages are recorded.

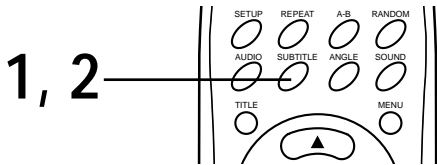

- 1 Press **SUBTITLE** during playback.  
When no subtitles are recorded, "OFF" will be displayed instead of the language number.



- 2 Press **SUBTITLE** repeatedly until the desired language is selected.  
Number of the subtitle language being played back is shown.



### Notes

- In some cases, the subtitle language is not changed to the selected one immediately.
- When a disc supporting the closed caption is played, the subtitle and the closed caption may overlap each other on the TV screen. In this case, turn the subtitle off.
- When the desired language is not selected even after pressing the button several times, it means that the language is not available on the disc.
- When the power is turned on or the disc is removed, subtitles appears in the language selected at the initial settings. If this language is not recorded on the disc, the disc's priority language appears.

**To eliminate the On Screen Subtitles.**  
Press SUBTITLE repeatedly to select OFF at step 2.

## Changing audio soundtrack language



It is possible to change the audio soundtrack language (or encoding method, channel number) to a different language from the one selected at the initial settings in case of DVD disc. (See page 19 for further info.) This operation works only with discs on which multiple audio soundtrack languages are recorded.

And it is possible to change the audio channel in case of audio CD.

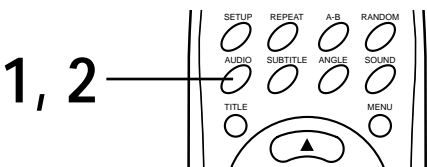

- DVD
- 1 Press **AUDIO** during play.  
Number of the audio soundtrack language being played back.



- 2 Press **AUDIO** repeatedly until the desired language (or encoding method, channel number) is selected.



- CD
- 1 Press **AUDIO** during play.



- 2 Press **AUDIO** repeatedly until the desired sound is selected.



### Notes

- When the desired language is not selected even after pressing the button several times, it means that the language is not available on the disc.
- When the power is turned on or the disc is removed, the language heard is the one selected at the initial settings. If this language is not recorded on the disc, only the available language on the disc will be heard.
- Some discs may not respond to Audio feature.



## Viewing from another angle

Some DVDs may contain scenes which have been shot simultaneously from a number of different angles. For these discs, the same scene can be viewed from each of these different angles using the ANGLE button. (The recorded angles differ depending on the disc used.)

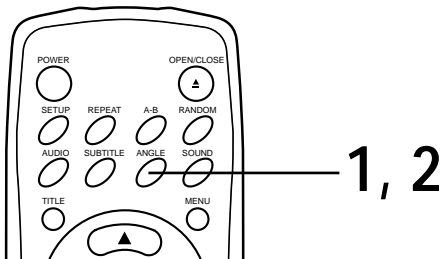
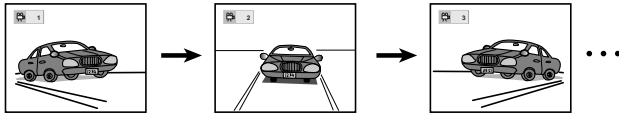

**1** Press ANGLE during playback.

Number of angle being played back.



**2** Press ANGLE repeatedly until the desired angle is selected.



### For your reference

- The ANGLE indicator will blink in the DVD display window at scenes recorded at different angles to indicate that angle switching is possible.
- The angle number can be programmed beforehand; the angle will be switched to the selected number when the ANGLE indicator blinks.

### Note

- This function only works for discs having scenes recorded at different angles.

## Producing a 3D SURROUND effect



This unit can produce a 3D Surround effect, using 3D Surround Sound technology, which simulates multi-channel audio playback from two conventional stereo speakers instead of the five or more speakers normally required to listen to multi-channel audio from a home theater. This feature works with DVD discs encoded with Dolby Pro Logic and Dolby Digital audio tracks.

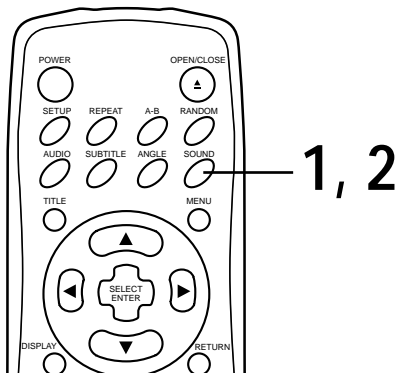

**1** Press SOUND during playback.

Each time this button is pressed, the TV screen display changes.



**2** Press SOUND repeatedly until the desired sound is selected.



### Notes

- This 3D Surround effect may not be available on some DVD discs or audio CD, such as those recorded with a mono audio soundtrack.
- Turn off the TV surround sound and other surround effects when using this 3D surround effect.
- For best 3D Surround effect using only two speakers it is recommended that the two speakers be positioned approximately 8' to 10' apart, and the listening position should be 8' to 10' away from the speakers.



## Repeat Play

### Repeating viewing (listening)

Press REPEAT during playback.

Each time this button is pressed, the TV screen changes as shown below and the disc will repeat a chapter or title (DVD) or a track (CD).

#### • DVD

Repeat of chapter being played

Repeat of title being played

Cancel repeat mode (normal play)

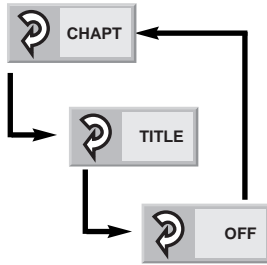

#### • CD

Repeat of track being played

Repeat of entire current disc contents

Repeat of entire all disc contents

Cancels repeat mode (normal play)

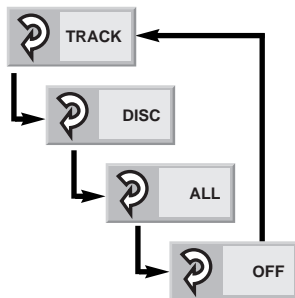

### To enjoy program repeat play (CD)

If REPEAT is pressed during program play, repeat play is operated as below.

Repeat of the current programmed track

Repeat of all programs

Cancel repeat mode (Program play)

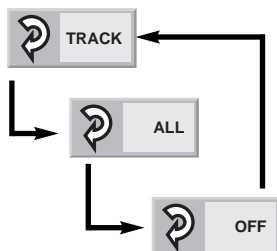

### To return to normal play

Press REPEAT several times until "OFF" is displayed.

### Repeating sections between two specific points (A-B repeat)

1 Press A-B during play at the point where repeat play is to start (A).



- You can select "OFF" at this step by pressing CLEAR.

2 Press A-B during play at the point where repeat play is to be concluded (B).



Repeat play of the selection between points A and B starts.

### To return to normal play

Press A-B once "OFF" is displayed.



#### Notes

- Repeat play works only with discs for which the elapsed playing time appears in the DVD display window during playback.
- Repeat play may not work correctly with some DVDs.
- A-B repeat play works only within a title DVD or a track CD.
- Some subtitles recorded around point A or B may fail to appear (DVD).

## Storing markers in memory to be viewed (listened to) again



Storing a MARKER in the DVD memory is similar to marking your page in a book. It allows you to quickly return to any point on the disc.

### Storing a marker in the memory

- 1 Press **MARKER** during play at the starting point to be viewed (listened to) again.



Indicates "1/9" is stored in the memory.  
Up to 9 marks can be stored in the memory.

### Recalling/Clearing a marker

- 2 Press **SEARCH** during playback.  
The **MARKER SEARCH** menu will appear on the TV screen.



- 3 Press **◀/▶** to select the marker to be recalled/cleared.
- 4 Press **SELECT/ENTER** to recall a marker.  
Or press **CLEAR** to clear a marker.  
Play resumes from the point corresponding to the selected marker, or the selected marker is cleared.

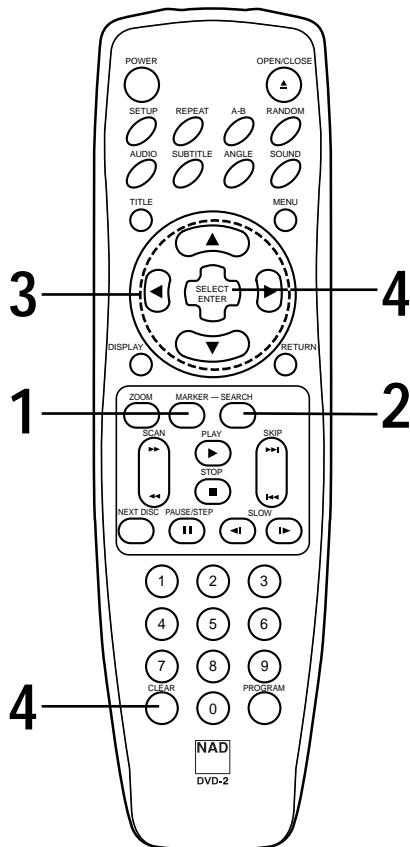

#### Notes

- These operations work only with discs for which the elapsed playing time appears in the DVD display window during playback or stop.
- Some subtitles recorded around the marker may fail to appear (DVD).
- All the markers are cleared when the power is turned off or the disc is removed.
- The marker is not stored when the DVD or title menu is displayed on the TV screen.





## Zoom Feature

The Zoom function allows you to enlarge the video image and to move through the enlarged image.

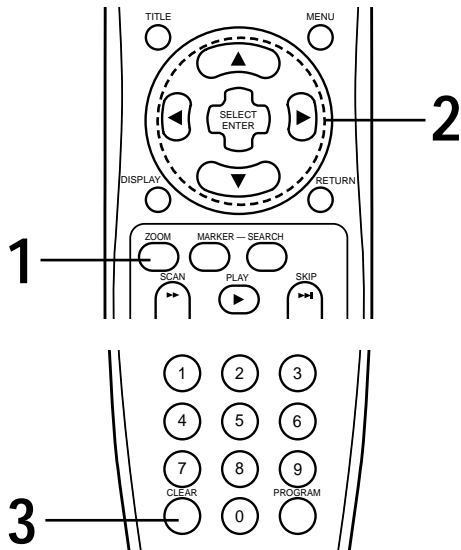

- 1** Press **ZOOM** during playback or still playback to activate the Zoom function. If you further press ZOOM repeatedly, the magnification level increases (6 steps).
- 2** Press **▲/▼/◀/▶** buttons to move through the zoomed picture.
- 3** Press **CLEAR** to resume normal playback.

### Notes

- Some discs may not respond to the Zoom feature.
- Zoom does not work on subtitles or menus included on DVD video discs.

## Random Play



**Note:** This function only works with audio CD discs. Random does not work with DVD movies.

You can playback titles or tracks in random order. (Random playback)

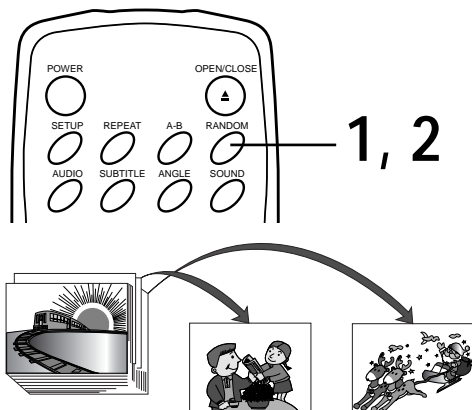

### Random play (CD only)

- 1** Press **RANDOM** repeatedly until desired random mode is selected during playback or stop mode. The unit automatically begins Random Playback and **RANDOM (1-3)** appears on the TV screen.
  - **RANDOM1:** Plays all the tracks on a single disc in random order and then stops.
  - **RANDOM2:** Plays all the tracks on current disc in random order and then plays all the tracks on each succeeding disc in random order and then stops.
  - **RANDOM3:** Plays 2 tracks randomly from a disc and then plays 2 tracks randomly from a different disc until all tracks on all discs have been played.
- 2** To return to normal playback, press **RANDOM** repeatedly until **NORMAL** appears on the TV screen. The **RANDOM** indicator in the DVD display window disappears.

### Notes

- Random playback may not be possible on certain discs.
- If you press the **SKIP** ◀◀ or ▶▶ button during random playback, the DVD player goes to another track randomly and starts playback.
- Random playback may not be possible on MP3 encoded discs.



## Program play

The player plays the tracks on the disc in the order you specify.

**Note:** Program play function is possible only with audio CDs. It does not work with DVD movie discs.

- 1 Press PROGRAM in the stop mode.**  
The program playback screen appears on the TV screen.

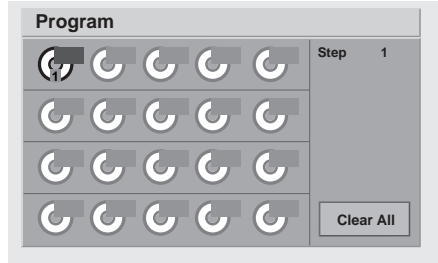

- To exit the screen, press PROGRAM or RETURN.

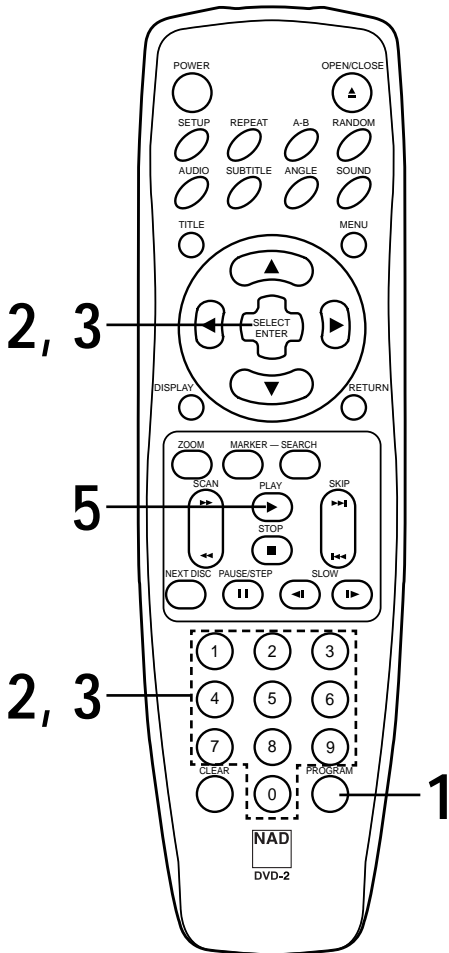

- 2 Enter the disc number using the numerical keys (1-5) and then press SELECT/ENTER.**
- 3 Enter the track number using the numerical keys (0-9) and then press SELECT/ENTER.**  
The next area is selected.
- 4 Repeat steps 2 to 3.**  
Up to 20 tracks can be programmed.
- 5 Press PLAY to exit the screen.**  
The selected tracks are stored in the player memory and playback begins with the first programmed sequence.

**After playback of all tracks programmed**  
Play is stopped.

### Clearing the program

- To clear the programmed tracks one by one**  
Press ▲/▼/◀/▶ to select the unwanted number and then press CLEAR.
- To clear all the programmed tracks**  
Press ▲/▼/◀/▶ to select "Clear All" and then press SELECT/ENTER. Press PROGRAM or RETURN to exit the screen. (The programs are also cleared when the power is turned off or the disc is removed.)

Playback with MP3

**MP3**

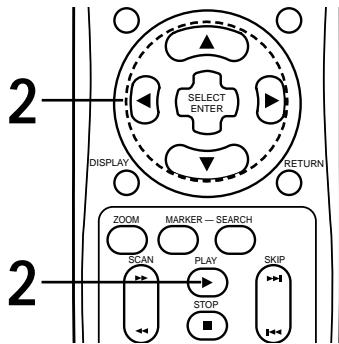

To play an MP3 file

- 1 Load an MP3 disc.  
The MP3 menu is displayed.

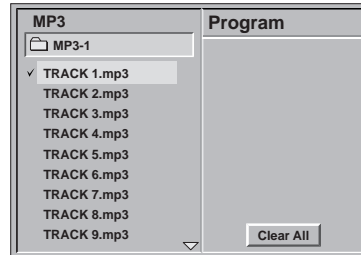

- 2 Press ▲/▼ button to select the desired MP3 file and then press PLAY to start playback of the file.

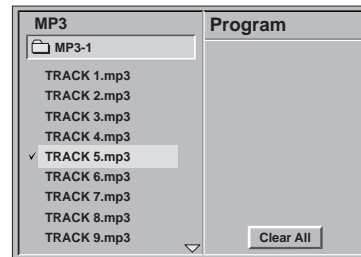

To play an MP3 file repeatedly

- If you press REPEAT once during play, the current MP3 file will play repeatedly.
- If you press REPEAT twice during play, all MP3 files on the disc will play repeatedly.
- If you press REPEAT three times, repeat play will be cancelled.

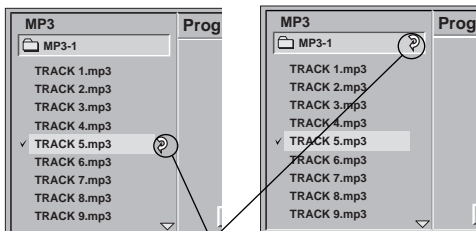

REPEAT symbol

Notes

- The file name is only displayed in English.
- If there is an impossible code to display, it will be displayed underlined ( \_ ) instead of English.
- This unit can play up to 200 files per disc. A disc recorded with more than 200 files cannot be played.
- Disc format is compatible with ISO9660 only.
- If you record MP3 files using the software which cannot create a FILE SYSTEM, for example "Direct-CD" etc., it is impossible to playback MP3 files. We therefore recommend that you use "Easy-CD Creator", which creates an ISO9660 file system.
- A single session disc requires MP3 files in the first track. If there is no MP3 file in the 1st track, it cannot playback MP3 files. If you wish to playback MP3 files, format all the data in the disc or use a new one.
- If there are already data files which are not MP3 files on the CD-R disc, please, do not use that disc; use a new one instead. However, if the disc is a CD-RW disc, this does not apply.
- Direct access to individual tracks may not work with MP3 encoded discs.

For your reference

- Press SKIP ►► to play the next file or previous file during playback.
- Press DISPLAY to move to the next page.
- Press PAUSE/STEP to enter the pause mode, press PLAY or PAUSE/STEP again to return to normal playback.
- Press STOP to stop the playback.

Playback with MP3 (Cont'd)

**MP3**

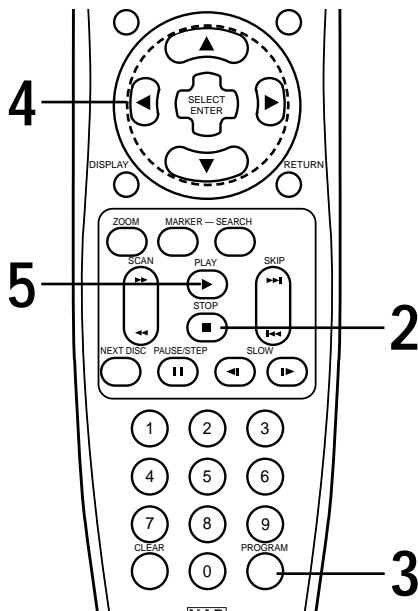

To program play an MP3 file

- 1** Load an MP3 disc.  
The MP3 menu is displayed.
- 2** Press **STOP** to stop playback.
- 3** Press **PROGRAM** to enter the Program Edition mode in the stop mode.  
The mark appears on the right of the word Program on the right side of MP3 menu.  
Press **RETURN** to exit the Program Edition mode, the mark will disappear.
- 4** Press **▲/▼** to select the desired MP3 file and then press **SELECT/ENTER** to add the MP3 file to the program list.
  - Repeat step 4 to select another track.
  - Up to 60 files can be programmed.

To play an MP3 file repeatedly

- If you press **REPEAT** button once during play, the current MP3 file will play repeatedly.
- If you press **REPEAT** button twice during play, all MP3 files on the program list will play repeatedly.
- If you press **REPEAT** button three times, repeat play will be cancelled.

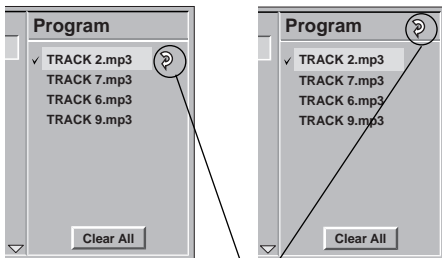

REPEAT symbol

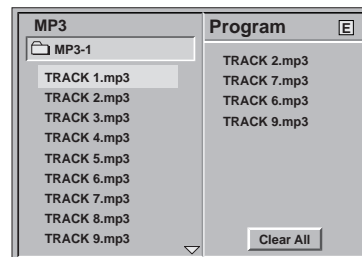

- 5** Press **PLAY** to play.  
The playback now begins in the programmed sequence.

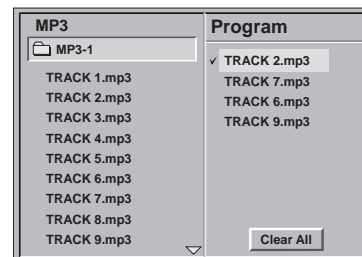

Clearing the program

- To clear the program one by one  
In the Program Edition mode, press **▲/▼/◀/▶** to select the unwanted MP3 file on the program list and then press **CLEAR**.
- To clear all the programs  
In the Program Edition mode, press **▲/▼/◀/▶** to select the "Clear All" and press **SELECT/ENTER**.



If you want to enter the main menu, press **◀** button.

After playback of all tracks programmed  
Play is stopped.

## Disc Requirements/Copyright Information

### Playable Discs

This DVD player can play back the following discs.

	Disc mark	Contents	Disc size	Maximum playback time
DVD video discs		Audio+Video (moving pictures)	12 cm	Approx. 4 hours (single sided disc)
				Approx. 8 hours (double sided disc)
			8 cm	Approx. 80 minutes (single sided disc)
				Approx. 160 minutes (double sided disc)
Audio CDs		Audio	12 cm	74 minutes
			8 cm	20 minutes

In addition, this unit can play back a CD-R or CD-RW that contains audio titles or MP3 files. And this unit can play back a HDCD also.

You cannot playback discs other than those listed above. (Video CD, CD-ROM, CD-Extra, CD-G, photo CD, and CD-i discs can not be played on this DVD player.)

, HDCD®, High Definition Compatible Digital® and Pacific Microsonics™ are either registered trademarks or trademarks of Pacific Microsonics, Inc., in the United States and/or other countries. HDCD system manufactured under license from Pacific Microsonics, Inc. This product is covered by one or more of the following: In the USA: 5,479,168; 5,638,074; 5,640,161; 5,808,574; 5,838,274; 5,854,600; 5,864,311; 5,872,531; and in Australia: 669114. Other patents pending.

### Region Management Information

Region Management Information: This DVD Player is designed and manufactured to respond to the Region Management Information that is recorded on a DVD disc. If the Region number described on the DVD disc does not correspond to the Region number of this DVD player, this DVD player cannot play that disc.



The Region number of this DVD player is 1.

### Notes on Unauthorized Discs

You may not be able to play back some DVD video discs on this player if they were purchased from outside your geographic area or made for business purposes.

When you try to play back an unauthorized disc, "Check Regional Code" appears on the TV screen.

### Notes on Copyright

It is forbidden by law to copy, broadcast, show, broadcast on cable, play in public, and rent copyrighted material without permission.

DVD video discs are copy protected, and any recordings made from these discs will be distorted.

This product incorporates copyright protection technology that is protected by method claims of certain U.S. patents and other intellectual property rights owned by Macrovision Corporation and other rights owners. Use of this copyright protection technology must be authorized by Macrovision Corporation, and is intended for home and other limited viewing uses only, unless otherwise authorized by Macrovision Corporation. Reverse engineering or disassembly is prohibited.

## Before Calling Service Personnel

### Symptoms and Correction

Check the following guide for the possible cause of a problem before contacting service.

Symptom	Cause	Correction
No power.	<ul style="list-style-type: none"> <li>The power cord is disconnected.</li> </ul>	<ul style="list-style-type: none"> <li>Plug the power cord into the wall outlet securely.</li> </ul>
The power is on, but the DVD player does not work.	<ul style="list-style-type: none"> <li>No disc is inserted.</li> </ul>	<ul style="list-style-type: none"> <li>Insert a disc. (Check that the DVD or, audio CD indicator in the DVD display is lit.)</li> </ul>
No picture.	<ul style="list-style-type: none"> <li>The TV is not set to receive DVD signal output.</li> </ul>	<ul style="list-style-type: none"> <li>Select the appropriate video input mode on the TV so the picture from the DVD player appears on the TV screen.</li> </ul>
	<ul style="list-style-type: none"> <li>The video cable is not connected securely.</li> </ul>	<ul style="list-style-type: none"> <li>Connect the video cable into the jacks securely.</li> </ul>
	<ul style="list-style-type: none"> <li>The connected TV power is turned off.</li> </ul>	<ul style="list-style-type: none"> <li>Turn on the TV.</li> </ul>
No sound.	<ul style="list-style-type: none"> <li>The equipment connected with the audio cable is not set to receive DVD signal output.</li> </ul>	<ul style="list-style-type: none"> <li>Select the correct input mode of the audio receiver so you can listen to the sound from the DVD player.</li> </ul>
	<ul style="list-style-type: none"> <li>The audio cables are not connected securely.</li> </ul>	<ul style="list-style-type: none"> <li>Connect the audio cable into the jacks securely.</li> </ul>
	<ul style="list-style-type: none"> <li>The power of the equipment connected with the audio cable is turned off.</li> </ul>	<ul style="list-style-type: none"> <li>Turn on the equipment connected with the audio cable.</li> </ul>
	<ul style="list-style-type: none"> <li>The Digital Audio Output is set to the wrong position.</li> </ul>	<ul style="list-style-type: none"> <li>Set the Digital Audio Output to the correct position, then turn on the DVD player again by pressing the POWER button.</li> </ul>
The playback picture is poor.	<ul style="list-style-type: none"> <li>The disc is dirty.</li> </ul>	<ul style="list-style-type: none"> <li>Clean the disc.</li> </ul>
The DVD player does not start playback.	<ul style="list-style-type: none"> <li>No disc is inserted.</li> </ul>	<ul style="list-style-type: none"> <li>Insert a disc. (Check that the DVD, or audio CD indicator in the DVD display is lit.)</li> </ul>
	<ul style="list-style-type: none"> <li>An unplayable disc is inserted.</li> </ul>	<ul style="list-style-type: none"> <li>Insert a playable disc. (Check the disc type, color system and Regional code.)</li> </ul>
	<ul style="list-style-type: none"> <li>The disc is placed upside down.</li> </ul>	<ul style="list-style-type: none"> <li>Place the disc with the playback side down.</li> </ul>
	<ul style="list-style-type: none"> <li>The disc is not placed within the guide.</li> </ul>	<ul style="list-style-type: none"> <li>Place the disc on the disc tray correctly inside the guide.</li> </ul>
	<ul style="list-style-type: none"> <li>The disc is dirty.</li> </ul>	<ul style="list-style-type: none"> <li>Clean the disc.</li> </ul>
	<ul style="list-style-type: none"> <li>A menu is on the TV screen.</li> </ul>	<ul style="list-style-type: none"> <li>Press the SETUP button to turn off the menu screen.</li> </ul>
	<ul style="list-style-type: none"> <li>The Rating level is set.</li> </ul>	<ul style="list-style-type: none"> <li>Cancel the Rating function or change the rating level.</li> </ul>
The remote control does not work properly.	<ul style="list-style-type: none"> <li>The remote control is not pointed at the remote sensor of the DVD player.</li> </ul>	<ul style="list-style-type: none"> <li>Point the remote control at the remote sensor of the DVD player.</li> </ul>
	<ul style="list-style-type: none"> <li>The remote control is too far from the DVD player.</li> </ul>	<ul style="list-style-type: none"> <li>Operate the remote control within about 23 ft (7 m).</li> </ul>
	<ul style="list-style-type: none"> <li>There is an obstacle in the path of the remote control and the DVD player.</li> </ul>	<ul style="list-style-type: none"> <li>Remove the obstacle.</li> </ul>
	<ul style="list-style-type: none"> <li>The batteries in the remote control are exhausted.</li> </ul>	<ul style="list-style-type: none"> <li>Replace the batteries with new ones.</li> </ul>

**Specifications**

**DVD player/Outputs/Supplied Accessories**

[DVD player]	Power supply	AC 120V, 60 Hz
	Power consumption	16 W
	Weight	12.6 lbs (5.7 kg)
	External dimensions (W X H X D)	17" X 4.7" X 16.2" (430 x 118 x 411 mm)
	Signal system	NTSC
	Laser	Semiconductor laser, wavelength 650 nm (DVD), 780 nm (CD)
	Frequency range (audio)	4 Hz to 20 kHz
	Signal-to-noise ratio (audio)	More than 95 dB (EIAJ)
	Dynamic range (audio)	More than 90 dB (EIAJ)
	Harmonic distortion (audio)	0.008 %
	Operating conditions	Temperature: 41°F to 95°F, Operation status: Horizontal
[Outputs]	Video output	1.0 V (p-p), 75 Ω, negative sync., RCA jack x 1
	S-video output	(Y) 1.0 V (p-p), 75 Ω, negative sync., Mini DIN 4-pin x 1 (C) 0.286 V (p-p), 75 Ω
	Component video output	(Y) 1.0 V (p-p), 75 Ω, negative sync., RCA jack x 1 (Pb)/(Pr) 0.7 V (p-p), 75 Ω
	Audio output (digital audio)	0.5 V (p-p), 75 Ω, RCA jack x 1
	Audio output (optical audio)	Optical connector x 1
	Audio output (analog audio)	1.0 Vrms(1 KHz, -6 dB), 330 Ω, RCA jack (L, R) x 1
[Supplied Accessories]	<ul style="list-style-type: none"> <li>● Video cable .....1</li> <li>● Audio cable .....1</li> <li>● Remote control.....1</li> <li>● Batteries .....2</li> </ul>	

\* Designs and specifications are subject to change without notice.

